



## U.S. Department of Labor Occupational Safety & Health Administration

[www.osha.gov](http://www.osha.gov)

MyOSHA  Search



Advanced Search | [A-Z Index](#)



[Technical Links](#) > [OSHA Technical Manual](#)



[Printing Instructions](#)

# OSHA Technical Manual

[TABLE OF CONTENTS](#)

[NEXT CHAPTER](#)

## SECTION IV: CHAPTER 2

### PETROLEUM REFINING PROCESSES

#### Contents:

- [I. Introduction](#)
- [II. Overview of the Petroleum Industry](#)
- [III. Petroleum Refining Operations](#)
- [IV. Description of Petroleum Refining Processes and Related Health and Safety Considerations](#)
- [V. Other Refinery Operations](#)
- [VI. Bibliography](#)

#### [Appendix IV:2-1. Glossary](#)

#### I. INTRODUCTION.

- A. The petroleum industry began with the successful drilling of the first commercial oil well in 1859, and the opening of the first refinery two years later to process the crude into kerosene. The evolution of petroleum refining from simple distillation to today's sophisticated processes has created a need for health and safety management procedures and safe work practices. To those unfamiliar with the industry, petroleum refineries may appear to be complex and confusing places. Refining is the processing of one complex mixture of hydrocarbons into a number of other complex mixtures of hydrocarbons. The safe and orderly processing of crude oil into flammable gases and liquids at high temperatures and pressures using vessels, equipment, and piping subjected to stress and corrosion requires considerable knowledge, control, and expertise.
- B. Safety and health professionals, working with process, chemical, instrumentation, and metallurgical engineers, assure that potential physical, mechanical, chemical, and health hazards are recognized and provisions are made for safe operating practices and appropriate protective measures. These measures may include hard hats, safety glasses and goggles, safety shoes, hearing protection, respiratory protection, and protective clothing such as fire resistant clothing where required. In addition, procedures should be established to assure compliance with applicable regulations and standards such as hazard communications, confined space entry, and process safety management.
- C. This chapter of the technical manual covers the history of refinery processing, characteristics of crude oil, hydrocarbon types and chemistry, and major refinery products and by-products. It presents information on technology as normally practiced in present operations. It describes the more common refinery processes and includes relevant safety and health information. Additional information covers refinery

utilities and miscellaneous supporting activities related to hydrocarbon processing. Field personnel will learn what to expect in various facilities regarding typical materials and process methods, equipment, potential hazards, and exposures.

- D. The information presented refers to fire prevention, industrial hygiene, and safe work practices, and is not intended to provide comprehensive guidelines for protective measures and/or compliance with regulatory requirements. As some of the terminology is industry-specific, a glossary is provided as an appendix. This chapter does not cover petrochemical processing.

## II. OVERVIEW OF THE PETROLEUM INDUSTRY.

A. **BASIC REFINERY PROCESS: DESCRIPTION AND HISTORY.** Petroleum refining has evolved continuously in response to changing consumer demand for better and different products. The original requirement was to produce kerosene as a cheaper and better source of light than whale oil. The development of the internal combustion engine led to the production of gasoline and diesel fuels. The evolution of the airplane created a need first for high-octane aviation gasoline and then for jet fuel, a sophisticated form of the original product, kerosene. Present-day refineries produce a variety of products including many required as feedstock for the petrochemical industry.

1. **Distillation Processes.** The first refinery, opened in 1861, produced kerosene by simple atmospheric distillation. Its by-products included tar and naphtha. It was soon discovered that high-quality lubricating oils could be produced by distilling petroleum under vacuum. However, for the next 30 years kerosene was the product consumers wanted. Two significant events changed this situation: (1) invention of the electric light decreased the demand for kerosene, and (2) invention of the internal combustion engine created a demand for diesel fuel and gasoline (naphtha).
2. **Thermal Cracking Processes.** With the advent of mass production and World War I, the number of gasoline-powered vehicles increased dramatically and the demand for gasoline grew accordingly. However, distillation processes produced only a certain amount of gasoline from crude oil. In 1913, the thermal cracking process was developed, which subjected heavy fuels to both pressure and intense heat, physically breaking the large molecules into smaller ones to produce additional gasoline and distillate fuels. Visbreaking, another form of thermal cracking, was developed in the late 1930's to produce more desirable and valuable products.
3. **Catalytic Processes.** Higher-compression gasoline engines required higher-octane gasoline with better antiknock characteristics. The introduction of catalytic cracking and polymerization processes in the mid- to late 1930's met the demand by providing improved gasoline yields and higher octane numbers.

Alkylation, another catalytic process developed in the early 1940's, produced more high-octane aviation gasoline and petrochemical feedstock for explosives and synthetic rubber. Subsequently, catalytic isomerization was developed to convert hydrocarbons to produce increased quantities of alkylation feedstock. Improved catalysts and process methods such as hydrocracking and reforming were developed throughout the 1960's to increase gasoline yields and improve antiknock characteristics. These catalytic processes also produced hydrocarbon molecules with a double bond (alkenes) and formed the basis of the modern petrochemical industry.

4. **Treatment Processes.** Throughout the history of refining, various treatment methods have been used to remove nonhydrocarbons, impurities, and other constituents that adversely affect the properties of finished products or reduce the efficiency of the conversion processes. Treating can involve chemical reaction and/or physical separation. Typical examples of treating are chemical sweetening, acid treating, clay contacting, caustic washing, hydrotreating, drying, solvent extraction, and solvent dewaxing. Sweetening compounds and acids desulfurize crude oil before processing and treat products during and after processing.

Following the Second World War, various reforming processes improved gasoline quality and yield and produced higher-quality products. Some of these involved the use of catalysts and/or hydrogen

to change molecules and remove sulfur. A number of the more commonly used treating and reforming processes are described in this chapter of the manual.

**TABLE IV: 2-1. HISTORY OF REFINING**

<b>Year</b>	<b>Process name</b>	<b>Purpose</b>	<b>By-products, etc.</b>
1862	Atmospheric distillation	Produce kerosene	Naphtha, tar, etc.
1870	Vacuum distillation	Lubricants (original) Cracking feedstocks (1930's)	Asphalt, residual coker feedstocks
1913	Thermal cracking	Increase gasoline	Residual, bunker fuel
1916	Sweetening	reduce sulfur & odor	Sulfur
1930	Thermal reforming	Improve octane number	Residual
1932	Hydrogenation	Remove sulfur	Sulfur
1932	Coking	Produce gasoline basestocks	Coke
1933	Solvent extraction	Improve lubricant viscosity index	Aromatics
1935	Solvent dewaxing	Improve pour point	Waxes
1935	Cat. polymerization	Improve gasoline yield & octane number	Petrochemical feedstocks
1937	Catalytic cracking	Higher octane gasoline	Petrochemical feedstocks
1939	Visbreaking	reduce viscosity	Increased distillate, tar
1940	Alkylation	Increase gasoline octane & yield	High-octane aviation gasoline
1940	Isomerization	Produce alkylation feedstock	Naphtha
1942	Fluid catalytic cracking	Increase gasoline yield & octane	Petrochemical feedstocks
1950	Deasphalting	Increase cracking feedstock	Asphalt
1952	Catalytic reforming	Convert low-quality naphtha	Aromatics
1954	Hydrodesulfurization	Remove sulfur	Sulfur
1956	Inhibitor sweetening	Remove mercaptan	Disulfides
1957	Catalytic isomerization	Convert to molecules with high octane number	Alkylation feedstocks
1960	Hydrocracking	Improve quality and reduce sulfur	Alkylation feedstocks
1974	Catalytic dewaxing	Improve pour point	Wax
1975	Residual hydrocracking	Increase gasoline yield from residual	Heavy residuals

## B. BASICS OF CRUDE OIL.

1. Crude oils are complex mixtures containing many different hydrocarbon compounds that vary in appearance and composition from one oil field to another. Crude oils range in consistency from

water to tar-like solids, and in color from clear to black. An "average" crude oil contains about 84% carbon, 14% hydrogen, 1%-3% sulfur, and less than 1% each of nitrogen, oxygen, metals, and salts. Crude oils are generally classified as paraffinic, naphthenic, or aromatic, based on the predominant proportion of similar hydrocarbon molecules. Mixed-base crudes have varying amounts of each type of hydrocarbon. Refinery crude base stocks usually consist of mixtures of two or more different crude oils.

2. Relatively simple crude oil assays are used to classify crude oils as paraffinic, naphthenic, aromatic, or mixed. One assay method (United States Bureau of Mines) is based on distillation, and another method (UOP "K" factor) is based on gravity and boiling points. More comprehensive crude assays determine the value of the crude (i.e., its yield and quality of useful products) and processing parameters. Crude oils are usually grouped according to yield structure.
3. Crude oils are also defined in terms of API (American Petroleum Institute) gravity. The higher the API gravity, the lighter the crude. For example, light crude oils have high API gravities and low specific gravities. Crude oils with low carbon, high hydrogen, and high API gravity are usually rich in paraffins and tend to yield greater proportions of gasoline and light petroleum products; those with high carbon, low hydrogen, and low API gravities are usually rich in aromatics.
4. Crude oils that contain appreciable quantities of hydrogen sulfide or other reactive sulfur compounds are called "sour." Those with less sulfur are called "sweet." Some exceptions to this rule are West Texas crudes, which are always considered "sour" regardless of their H<sub>2</sub>S content, and Arabian high-sulfur crudes, which are not considered "sour" because their sulfur compounds are not highly reactive.

**TABLE IV: 2-2. TYPICAL APPROXIMATE CHARACTERISTICS AND PROPERTIES AND GASOLINE POTENTIAL OF VARIOUS CRUDES (Representative average numbers)**

<b>Crude source</b>	<b>Paraffins (% vol)</b>	<b>Aromatics (% vol)</b>	<b>Naphthenes (% vol)</b>	<b>Sulfur (% wt)</b>	<b>API gravity (approx.)</b>	<b>Napht. yield (% vol)</b>	<b>Octane no (typical)</b>
Nigerian -Light	37	9	54	0.2	36	28	60
Saudi -Light	63	19	18	2	34	22	40
Saudi -Heavy	60	15	25	2.1	28	23	35
Venezuela -Heavy	35	12	53	2.3	30	2	60
Venezuela -Light	52	14	34	1.5	24	18	50
USA - Midcont. Sweet	-	-	-	0.4	40	-	-
USA -W. Texas	46	22	32	1.9	32	33	55

Sour							
North Sea -Brent	50	16	34	0.4	37	31	50

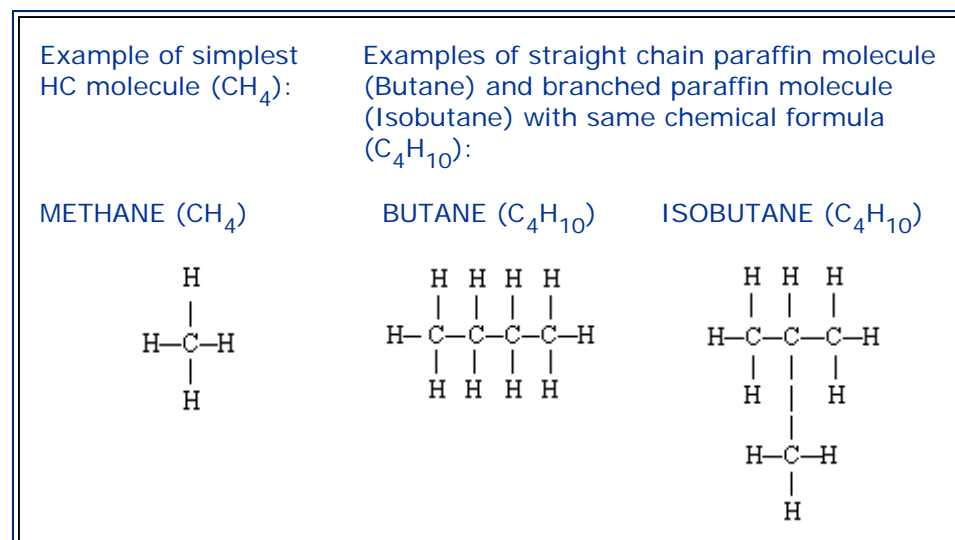
- C. **BASICS OF HYDROCARBON CHEMISTRY.** Crude oil is a mixture of hydrocarbon molecules, which are organic compounds of carbon and hydrogen atoms that may include from one to 60 carbon atoms. The properties of hydrocarbons depend on the number and arrangement of the carbon and hydrogen atoms in the molecules. The simplest hydrocarbon molecule is one carbon atom linked with four hydrogen atoms: methane. All other variations of petroleum hydrocarbons evolve from this molecule.

Hydrocarbons containing up to four carbon atoms are usually gases, those with 5 to 19 carbon atoms are usually liquids, and those with 20 or more are solids. The refining process uses chemicals, catalysts, heat, and pressure to separate and combine the basic types of hydrocarbon molecules naturally found in crude oil into groups of similar molecules. The refining process also rearranges their structures and bonding patterns into different hydrocarbon molecules and compounds. Therefore it is the type of hydrocarbon (paraffinic, naphthenic, or aromatic) rather than its specific chemical compounds that is significant in the refining process.

1. **Three Principal Groups or Series of Hydrocarbon Compounds that Occur Naturally in Crude Oil.**

- a. **Paraffins.** The paraffinic series of hydrocarbon compounds found in crude oil have the general formula  $C_nH_{2n+2}$  and can be either straight chains (normal) or branched chains (isomers) of carbon atoms. The lighter, straight-chain paraffin molecules are found in gases and paraffin waxes. Examples of straight-chain molecules are methane, ethane, propane, and butane (gases containing from one to four carbon atoms), and pentane and hexane (liquids with five to six carbon atoms). The branched-chain (isomer) paraffins are usually found in heavier fractions of crude oil and have higher octane numbers than normal paraffins. These compounds are saturated hydrocarbons, with all carbon bonds satisfied, that is, the hydrocarbon chain carries the full complement of hydrogen atoms.

**FIGURE IV:2-1. TYPICAL PARAFFINS.**



- b. **Aromatics** are unsaturated ring-type (cyclic) compounds which react readily because they have carbon atoms that are deficient in hydrogen. All aromatics have at least one benzene ring (a single-ring compound characterized by three double bonds alternating with three single bonds between six

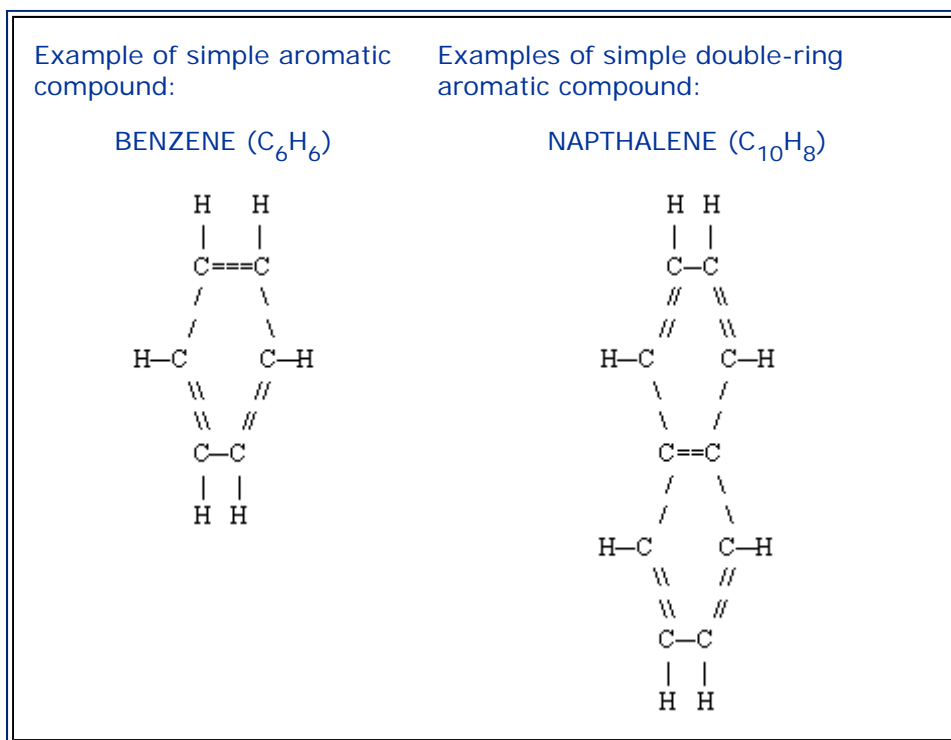
carbon atoms) as part of their molecular structure. Naphthalenes are fused double-ring aromatic compounds. The most complex aromatics, polynuclears (three or more fused aromatic rings), are found in heavier fractions of crude oil.

c. **Naphthenes** are saturated hydrocarbon groupings with the general formula  $C_nH_{2n}$ , arranged in the form of closed rings (cyclic) and found in all fractions of crude oil except the very lightest. Single-ring naphthenes (monocycloparaffins) with five and six carbon atoms predominate, with two-ring naphthenes (dicycloparaffins) found in the heavier ends of naphtha.

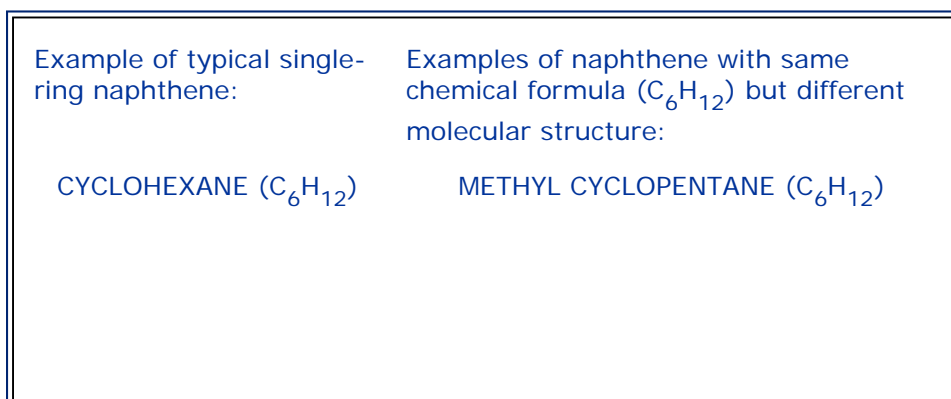
## 2. Other Hydrocarbons.

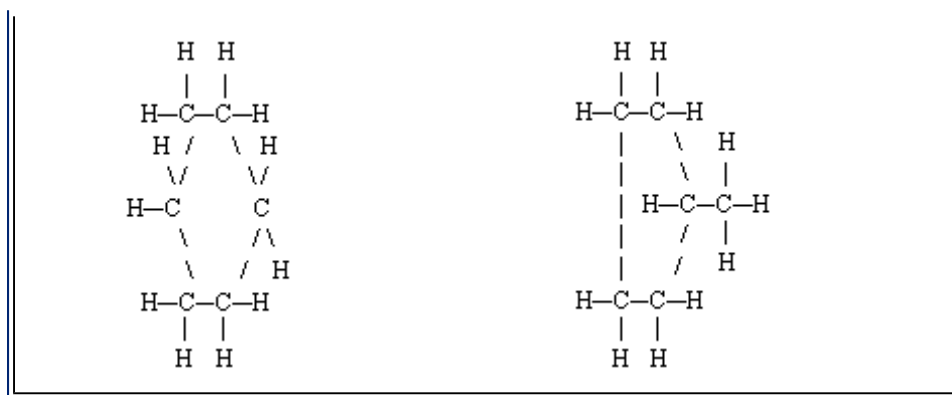
a. **Alkenes** are mono-olefins with the general formula  $C_nH_{2n}$  and contain only one carbon-carbon double bond in the chain. The simplest alkene is ethylene, with two carbon atoms joined by a double bond and four hydrogen atoms. Olefins are usually formed by thermal and catalytic cracking and rarely occur naturally in unprocessed crude oil.

**FIGURE IV:2-2. TYPICAL AROMATICS.**

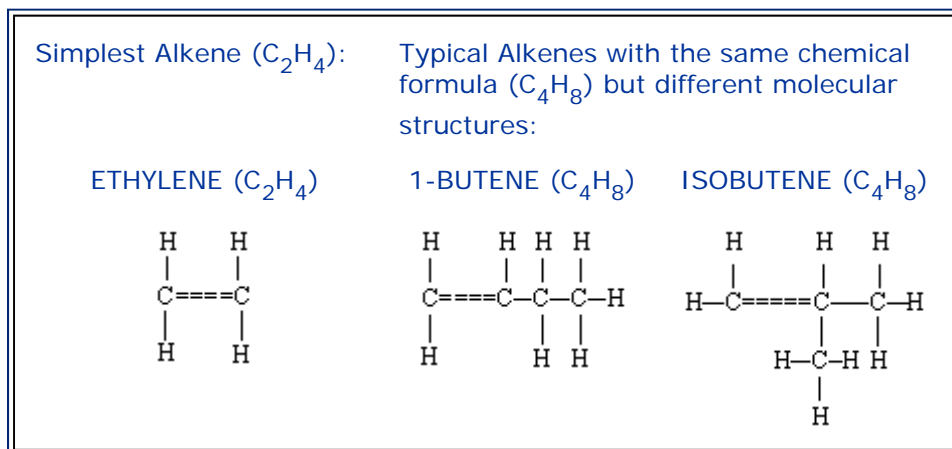


**FIGURE IV:2-3. TYPICAL NAPHTHENES.**



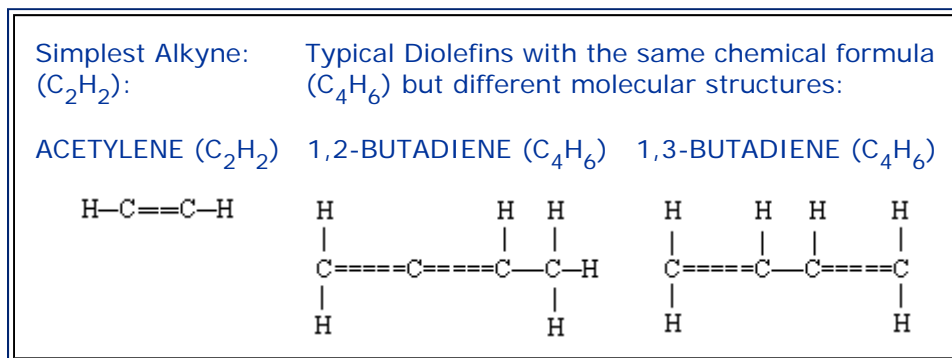


**FIGURE IV:2-4. TYPICAL ALKENES.**



b. **Dienes and Alkynes.** Dienes, also known as diolefins, have two carbon-carbon double bonds. The alkynes, another class of unsaturated hydrocarbons, have a carbon-carbon triple bond within the molecule. Both these series of hydrocarbons have the general formula C<sub>n</sub>H<sub>2n-2</sub>. Diolefins such as 1,2-butadiene and 1,3-butadiene, and alkynes such as acetylene, occur in C<sub>5</sub> and lighter fractions from cracking. The olefins, diolefins, and alkynes are said to be unsaturated because they contain less than the amount of hydrogen necessary to saturate all the valences of the carbon atoms. These compounds are more reactive than paraffins or naphthenes and readily combine with other elements such as hydrogen, chlorine, and bromine.

**FIGURE IV:2-5. TYPICAL DIOLEFINS AND ALKYNES.**



3. **Nonhydrocarbons.**

a. **Sulfur Compounds.** Sulfur may be present in crude oil as hydrogen sulfide ( $H_2S$ ), as compounds (e.g. mercaptans, sulfides, disulfides, thiophenes, etc.) or as elemental sulfur. Each crude oil has different amounts and types of sulfur compounds, but as a rule the proportion, stability, and complexity of the compounds are greater in heavier crude-oil fractions. Hydrogen sulfide is a primary contributor to corrosion in refinery processing units. Other corrosive substances are elemental sulfur and mercaptans. Moreover, the corrosive sulfur compounds have an obnoxious odor.

Pyrophoric iron sulfide results from the corrosive action of sulfur compounds on the iron and steel used in refinery process equipment, piping, and tanks. The combustion of petroleum products containing sulfur compounds produces undesirables such as sulfuric acid and sulfur dioxide. Catalytic hydrotreating processes such as hydrodesulfurization remove sulfur compounds from refinery product streams. Sweetening processes either remove the obnoxious sulfur compounds or convert them to odorless disulfides, as in the case of mercaptans.

b. **Oxygen Compounds.** Oxygen compounds such as phenols, ketones, and carboxylic acids occur in crude oils in varying amounts.

c. **Nitrogen Compounds.** Nitrogen is found in lighter fractions of crude oil as basic compounds, and more often in heavier fractions of crude oil as nonbasic compounds that may also include trace metals such as copper, vanadium, and/or nickel. Nitrogen oxides can form in process furnaces. The decomposition of nitrogen compounds in catalytic cracking and hydrocracking processes forms ammonia and cyanides that can cause corrosion.

d. **Trace Metals.** Metals, including nickel, iron, and vanadium are often found in crude oils in small quantities and are removed during the refining process. Burning heavy fuel oils in refinery furnaces and boilers can leave deposits of vanadium oxide and nickel oxide in furnace boxes, ducts, and tubes. It is also desirable to remove trace amounts of arsenic, vanadium, and nickel prior to processing as they can poison certain catalysts.

e. **Salts.** Crude oils often contain inorganic salts such as sodium chloride, magnesium chloride, and calcium chloride in suspension or dissolved in entrained water (brine). These salts must be removed or neutralized before processing to prevent catalyst poisoning, equipment corrosion, and fouling. Salt corrosion is caused by the hydrolysis of some metal chlorides to hydrogen chloride (HCl) and the subsequent formation of hydrochloric acid when crude is heated. Hydrogen chloride may also combine with ammonia to form ammonium chloride ( $NH_4Cl$ ), which causes fouling and corrosion.

f. **Carbon Dioxide.** Carbon dioxide may result from the decomposition of bicarbonates present in or added to crude, or from steam used in the distillation process.

g. **Naphthenic Acids.** Some crude oils contain naphthenic (organic) acids, which may become corrosive at temperatures above  $450^{\circ} F$  when the acid value of the crude is above a certain level.

#### D. MAJOR REFINERY PRODUCTS.

1. **Gasoline.** The most important refinery product is motor gasoline, a blend of hydrocarbons with boiling ranges from ambient temperatures to about  $400^{\circ} F$ . The important qualities for gasoline are octane number (antiknock), volatility (starting and vapor lock), and vapor pressure (environmental control). Additives are often used to enhance performance and provide protection against oxidation and rust formation.
2. **Kerosene.** Kerosene is a refined middle-distillate petroleum product that finds considerable use as a jet fuel and around the world in cooking and space heating. When used as a jet fuel, some of the critical qualities are freeze point, flash point, and smoke point. Commercial jet fuel has a boiling range of about  $375^{\circ}$ - $525^{\circ} F$ , and military jet fuel  $130^{\circ}$ - $550^{\circ} F$ . Kerosene, with less-critical

specifications, is used for lighting, heating, solvents, and blending into diesel fuel.

3. **Liquefied Petroleum Gas (LPG).** LPG, which consists principally of propane and butane, is produced for use as fuel and is an intermediate material in the manufacture of petrochemicals. The important specifications for proper performance include vapor pressure and control of contaminants.
4. **Distillate Fuels.** Diesel fuels and domestic heating oils have boiling ranges of about 400°-700° F. The desirable qualities required for distillate fuels include controlled flash and pour points, clean burning, no deposit formation in storage tanks, and a proper diesel fuel cetane rating for good starting and combustion.
5. **Residual Fuels.** Many marine vessels, power plants, commercial buildings and industrial facilities use residual fuels or combinations of residual and distillate fuels for heating and processing. The two most critical specifications of residual fuels are viscosity and low sulfur content for environmental control.
6. **Coke and Asphalt.** Coke is almost pure carbon with a variety of uses from electrodes to charcoal briquets. Asphalt, used for roads and roofing materials, must be inert to most chemicals and weather conditions.
7. **Solvents.** A variety of products, whose boiling points and hydrocarbon composition are closely controlled, are produced for use as solvents. These include benzene, toluene, and xylene.
8. **Petrochemicals.** Many products derived from crude oil refining, such as ethylene, propylene, butylene, and isobutylene, are primarily intended for use as petrochemical feedstock in the production of plastics, synthetic fibers, synthetic rubbers, and other products.
9. **Lubricants.** Special refining processes produce lubricating oil base stocks. Additives such as demulsifiers, antioxidants, and viscosity improvers are blended into the base stocks to provide the characteristics required for motor oils, industrial greases, lubricants, and cutting oils. The most critical quality for lubricating-oil base stock is a high viscosity index, which provides for greater consistency under varying temperatures.

#### E. COMMON REFINERY CHEMICALS.

1. **Leaded Gasoline Additives.** Tetraethyl lead (TEL) and tetramethyl lead (TML) are additives formerly used to improve gasoline octane ratings but are no longer in common use except in aviation gasoline.
2. **Oxygenates.** Ethyl tertiary butyl ether (ETBE), methyl tertiary butyl ether (MTBE), tertiary amyl methyl ether (TAME), and other oxygenates improve gasoline octane ratings and reduce carbon monoxide emissions.
3. **Caustics.** Caustics are added to desalting water to neutralize acids and reduce corrosion. They are also added to desalted crude in order to reduce the amount of corrosive chlorides in the tower overheads. They are used in some refinery treating processes to remove contaminants from hydrocarbon streams.
4. **Sulfuric Acid and Hydrofluoric Acid.** Sulfuric acid and hydrofluoric acid are used primarily as catalysts in alkylation processes. Sulfuric acid is also used in some treatment processes.

### III. PETROLEUM REFINING OPERATIONS.

- A. **INTRODUCTION.** Petroleum refining begins with the distillation, or fractionation, of crude oils into separate hydrocarbon groups. The resultant products are directly related to the characteristics of the

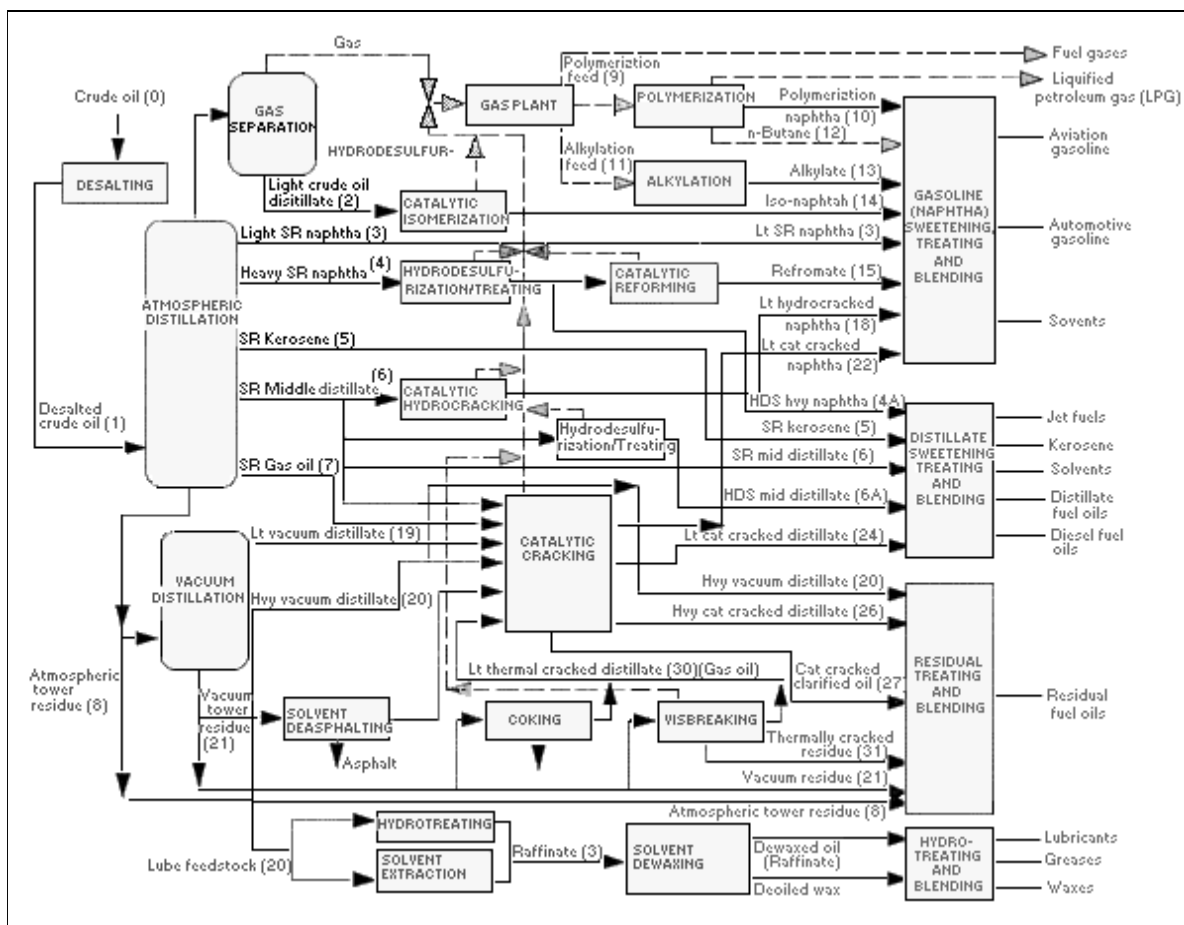
crude processed. Most distillation products are further converted into more usable products by changing the size and structure of the hydrocarbon molecules through cracking, reforming, and other conversion processes as discussed in this chapter. These converted products are then subjected to various treatment and separation processes such as extraction, hydrotreating, and sweetening to remove undesirable constituents and improve product quality. Integrated refineries incorporate fractionation, conversion, treatment, and blending operations and may also include petrochemical processing.

B. **REFINING OPERATIONS.** Petroleum refining processes and operations can be separated into five basic areas:

1. **Fractionation** (distillation) is the separation of crude oil in atmospheric and vacuum distillation towers into groups of hydrocarbon compounds of differing boiling-point ranges called "fractions" or "cuts."
2. **Conversion** processes change the size and/or structure of hydrocarbon molecules. These processes include:
  - Decomposition (dividing) by thermal and catalytic cracking;
  - Unification (combining) through alkylation and polymerization; and
  - Alteration (rearranging) with isomerization and catalytic reforming.
3. **Treatment** processes are intended to prepare hydrocarbon streams for additional processing and to prepare finished products. Treatment may include the removal or separation of aromatics and naphthenes as well as impurities and undesirable contaminants. Treatment may involve chemical or physical separation such as dissolving, absorption, or precipitation using a variety and combination of processes including desalting, drying, hydrodesulfurizing, solvent refining, sweetening, solvent extraction, and solvent dewaxing.
4. **Formulating and Blending** is the process of mixing and combining hydrocarbon fractions, additives, and other components to produce finished products with specific performance properties.
5. **Other Refining Operations** include: light-ends recovery; sour-water stripping; solid waste and wastewater treatment; process-water treatment and cooling; storage and handling; product movement; hydrogen production; acid and tail-gas treatment; and sulfur recovery.

Auxiliary operations and facilities include: steam and power generation; process and fire water systems; flares and relief systems; furnaces and heaters; pumps and valves; supply of steam, air, nitrogen, and other plant gases; alarms and sensors; noise and pollution controls; sampling, testing, and inspecting; and laboratory, control room, maintenance, and administrative facilities.

**FIGURE IV:2-6. REFINERY PROCESS CHART.**



**TABLE IV-2-3. OVERVIEW OF PETROLEUM REFINING PROCESSES.**

<u>Process name</u>	<u>Action</u>	<u>Method</u>	<u>Purpose</u>	<u>Feedstock(s)</u>	<u>Product(s)</u>
<b>FRACTIONATION PROCESSES</b>					
Atmospheric distillation	Separation	Thermal	Separate fractions	Desalted crude oil	Gas, gas oil, distillate, residual
Vacuum distillation	Separation	Thermal	Separate w/o cracking	Atmospheric tower residual	Gas oil, lube stock, residual
<b>CONVERSION PROCESSED--DECOMPOSITION</b>					
Catalytic cracking	Alteration	Catalytic	Upgrade gasoline	Gas oil, coke distillate	Gasoline, petrochemical feedstock
Coking	Polymerize	Thermal	Convert vacuum residuals	Gas oil, coke distillate	Gasoline, petrochemical feedstock
Hydro-cracking	Hydrogenate	Catalytic	Convert to lighter HC's	Gas oil, cracked oil, residual	Lighter, higher-quality products
*Hydrogen steam reforming	Decompose	Thermal/catalytic	Produce hydrogen	Desulfurized gas, O <sub>2</sub> , steam	Hydrogen, CO, CO <sub>2</sub>
*Steam cracking	Decompose	Thermal	Crack large molecules	Atm tower hvy fuel/distillate	Cracked naphtha, coke, residual
Visbreaking	Decompose	Thermal	reduce viscosity	Atmospheric tower	Distillate, tar

residual

**CONVERSION PROCESSES--UNIFICATION**

Alkylation	Combining	Catalytic	Unite olefins & isoparaffins	Tower isobutane/cracker olefin	Iso-octane (alkylate)
Grease compounding	Combining	Thermal	Combine soaps & oils	Lube oil, fatty acid, alky metal	Lubricating grease
Polymerizing	Polymerize	Catalytic	Unite 2 or more olefins	Cracker olefins	High-octane naphtha, petrochemical stocks

**CONVERSION PROCESSES--ALTERATION OR REARRANGEMENT**

Catalytic reforming	Alteration/dehydration	Catalytic	Upgrade low-octane naphtha	Coker/ hydro-cracker naphtha	High oct. Reformate/ aromatic
Isomerization	Rearrange	Catalytic	Convert straight chain to branch	Butane, pentane, hexane	Isobutane/ pentane/ hexane

**TREATMENT PROCESSES**

*Amine treating	Treatment	Absorption	Remove acidic contaminants	Sour gas, HCs w/CO <sub>2</sub> & H <sub>2</sub> S	Acid free gases & liquid HCs
Desalting	Dehydration	Absorption	Remove contaminants	Crude oil	Desalted crude oil
Drying & sweetening	Treatment	Abspt/therm	Remove H <sub>2</sub> O & sulfur cmpds	Liq Hcs, LPG, alky feedstk	Sweet & dry hydrocarbons
*Furfural extraction	Solvent extr.	Absorption	Upgrade mid distillate & lubes	Cycle oils & lube feed-stocks	High quality diesel & lube oil
Hydrodesulfurization	Treatment	Catalytic	Remove sulfur, contaminants	High-sulfur residual/ gas oil	Desulfurized olefins
Hydrotreating	Hydrogenation	Catalytic	Remove impurities, saturate HC's	Residuals, cracked HC's	Cracker feed, distillate, lube
*Phenol extraction	Solvent extr.	Abspt/therm	Improve visc. index, color	Lube oil base stocks	High quality lube oils
Solvent deasphalting	Treatment	Absorption	Remove asphalt	Vac. tower residual, propane	Heavy lube oil, asphalt
Solvent dewaxing	Treatment	Cool/ filter	Remove wax from lube stocks	Vac. tower lube oils	Dewaxed lube basestock
Solvent extraction	Solvent extr.	Abspt/precip.	Separate unsat. oils	Gas oil, reformate, distillate	High-octane gasoline
Sweetening	Treatment	Catalytic	Remv H <sub>2</sub> S, convert mercaptan	Untreated distillate/gasoline	High-quality distillate/gasoline

\* **Note:** These processes are not depicted in the refinery process flow chart.

#### IV. DESCRIPTION OF PETROLEUM REFINING PROCESSES AND RELATED HEALTH AND SAFETY CONSIDERATIONS.

##### A. CRUDE OIL PRETREATMENT (DESALTING).

###### 1. Description.

- a. Crude oil often contains water, inorganic salts, suspended solids, and water-soluble trace metals. As a first step in the refining process, to reduce corrosion, plugging, and fouling of equipment and

to prevent poisoning the catalysts in processing units, these contaminants must be removed by desalting (dehydration).

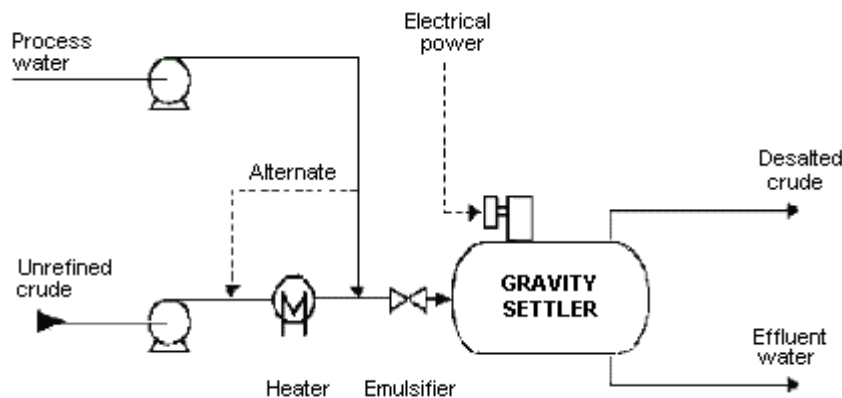
b. The two most typical methods of crude-oil desalting, chemical and electrostatic separation, use hot water as the extraction agent. In chemical desalting, water and chemical surfactant (demulsifiers) are added to the crude, heated so that salts and other impurities dissolve into the water or attach to the water, and then held in a tank where they settle out. Electrical desalting is the application of high-voltage electrostatic charges to concentrate suspended water globules in the bottom of the settling tank. Surfactants are added only when the crude has a large amount of suspended solids. Both methods of desalting are continuous. A third and less-common process involves filtering heated crude using diatomaceous earth.

c. The feedstock crude oil is heated to between 150° and 350°F to reduce viscosity and surface tension for easier mixing and separation of the water. The temperature is limited by the vapor pressure of the crude-oil feedstock. In both methods other chemicals may be added. Ammonia is often used to reduce corrosion. Caustic or acid may be added to adjust the pH of the water wash. Wastewater and contaminants are discharged from the bottom of the settling tank to the wastewater treatment facility. The desalted crude is continuously drawn from the top of the settling tanks and sent to the crude distillation (fractionating) tower.

**TABLE IV:2-4. DESALTING PROCESS.**

Feedstock From	Process	Typical products . . . To
Crude	Storage Treating	Desalted crude . . . Atmospheric distillation tower
		Waste water . . . . . Treatment

**FIGURE IV:2-7. ELECTROSTATIC DESALTING.**



**2. Health and Safety Considerations.**

a. **Fire Prevention and Protection.** The potential exists for a fire due to a leak or release of crude from heaters in the crude desalting unit. Low boiling point components of crude may also be released if a leak occurs.

b. **Safety.** Inadequate desalting can cause fouling of heater tubes and heat exchangers throughout the refinery. Fouling restricts product flow and heat transfer and leads to failures due to increased pressures and temperatures. Corrosion, which occurs due to the presence of hydrogen sulfide, hydrogen chloride, naphthenic (organic) acids, and other contaminants in the crude oil, also causes equipment failure. Neutralized salts (ammonium chlorides and sulfides), when moistened by condensed water, can cause corrosion. Overpressuring the unit is another potential hazard that

causes failures.

c. **Health.** Because this is a closed process, there is little potential for exposure to crude oil unless a leak or release occurs. Where elevated operating temperatures are used when desalting sour crudes, hydrogen sulfide will be present. There is the possibility of exposure to ammonia, dry chemical demulsifiers, caustics, and/or acids during this operation. Safe work practices and/or the use of appropriate personal protective equipment may be needed for exposures to chemicals and other hazards such as heat, and during process sampling, inspection, maintenance, and turnaround activities.

Depending on the crude feedstock and the treatment chemicals used, the wastewater will contain varying amounts of chlorides, sulfides, bicarbonates, ammonia, hydrocarbons, phenol, and suspended solids. If diatomaceous earth is used in filtration, exposures should be minimized or controlled. Diatomaceous earth can contain silica in very fine particle size, making this a potential respiratory hazard.

**B. CRUDE OIL DISTILLATION (FRACTIONATION).**

1. **Description.** The first step in the refining process is the separation of crude oil into various fractions or straight-run cuts by distillation in atmospheric and vacuum towers. The main fractions or "cuts" obtained have specific boiling-point ranges and can be classified in order of decreasing volatility into gases, light distillates, middle distillates, gas oils, and residuum.

2. **Atmospheric Distillation Tower.**

a. At the refinery, the desalted crude feedstock is preheated using recovered process heat. The feedstock then flows to a direct-fired crude charge heater where it is fed into the vertical distillation column just above the bottom, at pressures slightly above atmospheric and at temperatures ranging from 650° to 700° F (heating crude oil above these temperatures may cause undesirable thermal cracking). All but the heaviest fractions flash into vapor. As the hot vapor rises in the tower, its temperature is reduced. Heavy fuel oil or asphalt residue is taken from the bottom. At successively higher points on the tower, the various major products including lubricating oil, heating oil, kerosene, gasoline, and uncondensed gases (which condense at lower temperatures) are drawn off.

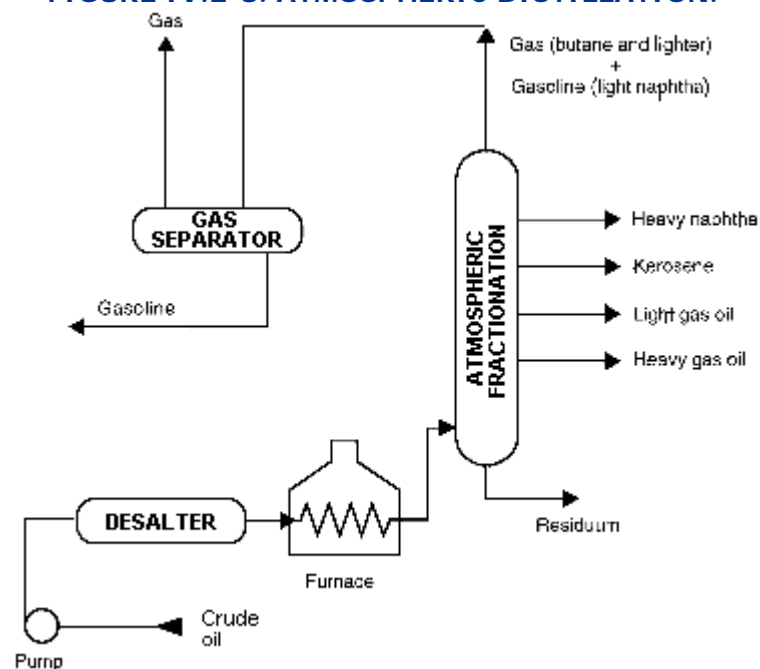
b. The fractionating tower, a steel cylinder about 120 feet high, contains horizontal steel trays for separating and collecting the liquids. At each tray, vapors from below enter perforations and bubble caps. They permit the vapors to bubble through the liquid on the tray, causing some condensation at the temperature of that tray. An overflow pipe drains the condensed liquids from each tray back to the tray below, where the higher temperature causes re-evaporation. The evaporation, condensing, and scrubbing operation is repeated many times until the desired degree of product purity is reached. Then side streams from certain trays are taken off to obtain the desired fractions. Products ranging from uncondensed fixed gases at the top to heavy fuel oils at the bottom can be taken continuously from a fractionating tower. Steam is often used in towers to lower the vapor pressure and create a partial vacuum. The distillation process separates the major constituents of crude oil into so-called straight-run products. Sometimes crude oil is "topped" by distilling off only the lighter fractions, leaving a heavy residue that is often distilled further under high vacuum.

**TABLE IV:2-5. ATMOSPHERIC DISTILLATION PROCESS**

<b>Feedstock From</b>	<b>Process</b>	<b>Typical products . . . . . To</b>
Crude	Desalting Separation	Gases . . . . . Atmospheric distillation tower
		Naphthas. . . . . Reforming or treating
		Kerosene or distillates . . Treating

Gas oil . . . . .	Catalytic cracking
Residual . . . . .	Vacuum tower or visbreaker

**FIGURE IV:2-8. ATMOSPHERIC DISTILLATION.**



3. **Vacuum Distillation Tower.** In order to further distill the residuum or topped crude from the atmospheric tower at higher temperatures, reduced pressure is required to prevent thermal cracking. The process takes place in one or more vacuum distillation towers. The principles of vacuum distillation resemble those of fractional distillation and, except that larger-diameter columns are used to maintain comparable vapor velocities at the reduced pressures, the equipment is also similar. The internal designs of some vacuum towers are different from atmospheric towers in that random packing and demister pads are used instead of trays. A typical first-phase vacuum tower may produce gas oils, lubricating-oil base stocks, and heavy residual for propane deasphalting. A second-phase tower operating at lower vacuum may distill surplus residuum from the atmospheric tower, which is not used for lube-stock processing, and surplus residuum from the first vacuum tower not used for deasphalting. Vacuum towers are typically used to separate catalytic cracking feedstock from surplus residuum.
4. **Other Distillation Towers (Columns).** Within refineries there are numerous other, smaller distillation towers called columns, designed to separate specific and unique products. Columns all work on the same principles as the towers described above. For example, a depropanizer is a small column designed to separate propane and lighter gases from butane and heavier components. Another larger column is used to separate ethyl benzene and xylene. Small "bubble" towers called strippers use steam to remove trace amounts of light products from heavier product streams.
5. **Health and Safety Considerations.**
  - a. **Fire Prevention and Protection.** Even though these are closed processes, heaters and exchangers in the atmospheric and vacuum distillation units could provide a source of ignition, and the potential for a fire exists should a leak or release occur.
  - b. **Safety.** An excursion in pressure, temperature, or liquid levels may occur if automatic control devices fail. Control of temperature, pressure, and reflux within operating parameters is needed to

prevent thermal cracking within the distillation towers. Relief systems should be provided for overpressure and operations monitored to prevent crude from entering the reformer charge.

The sections of the process susceptible to corrosion include (but may not be limited to) preheat exchanger (HCl and H<sub>2</sub>S), preheat furnace and bottoms exchanger (H<sub>2</sub>S and sulfur compounds), atmospheric tower and vacuum furnace (H<sub>2</sub>S, sulfur compounds, and organic acids), vacuum tower (H<sub>2</sub>S and organic acids), and overhead (H<sub>2</sub>S, HCl, and water). Where sour crudes are processed, severe corrosion can occur in furnace tubing and in both atmospheric and vacuum towers where metal temperatures exceed 450° F. Wet H<sub>2</sub>S also will cause cracks in steel. When processing high-nitrogen crudes, nitrogen oxides can form in the flue gases of furnaces. Nitrogen oxides are corrosive to steel when cooled to low temperatures in the presence of water.

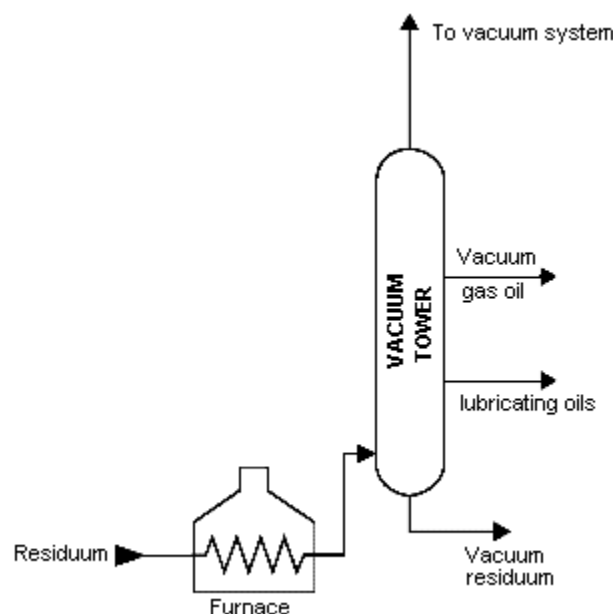
Chemicals are used to control corrosion by hydrochloric acid produced in distillation units. Ammonia may be injected into the overhead stream prior to initial condensation and/or an alkaline solution may be carefully injected into the hot crude-oil feed. If sufficient wash-water is not injected, deposits of ammonium chloride can form and cause serious corrosion. Crude feedstock may contain appreciable amounts of water in suspension which can separate during startup and, along with water remaining in the tower from steam purging, settle in the bottom of the tower. This water can be heated to the boiling point and create an instantaneous vaporization explosion upon contact with the oil in the unit.

c. **Health.** Atmospheric and vacuum distillation are closed processes and exposures are expected to be minimal. When sour (high-sulfur) crudes are processed, there is potential for exposure to hydrogen sulfide in the preheat exchanger and furnace, tower flash zone and overhead system, vacuum furnace and tower, and bottoms exchanger. Hydrogen chloride may be present in the preheat exchanger, tower top zones, and overheads. Wastewater may contain water-soluble sulfides in high concentrations and other water-soluble compounds such as ammonia, chlorides, phenol, mercaptans, etc., depending upon the crude feedstock and the treatment chemicals. Safe work practices and/or the use of appropriate personal protective equipment may be needed for exposures to chemicals and other hazards such as heat and noise, and during sampling, inspection, maintenance, and turnaround activities.

**TABLE IV:2-6. VACUUM DISTILLATION PROCESS**

<b>Feedstock</b>	<b>From</b>	<b>Process</b>	<b>Typical products . . . To</b>
Residuals	Atmospheric tower	Separation	Gas oils . . . . . Catalytic cracker Lubricants . . . . . Hydrotreating or solvent Residual . . . . . Deasphalter, visbreaker, or coker

**FIGURE IV:2-9. VACUUM DISTILLATION.**



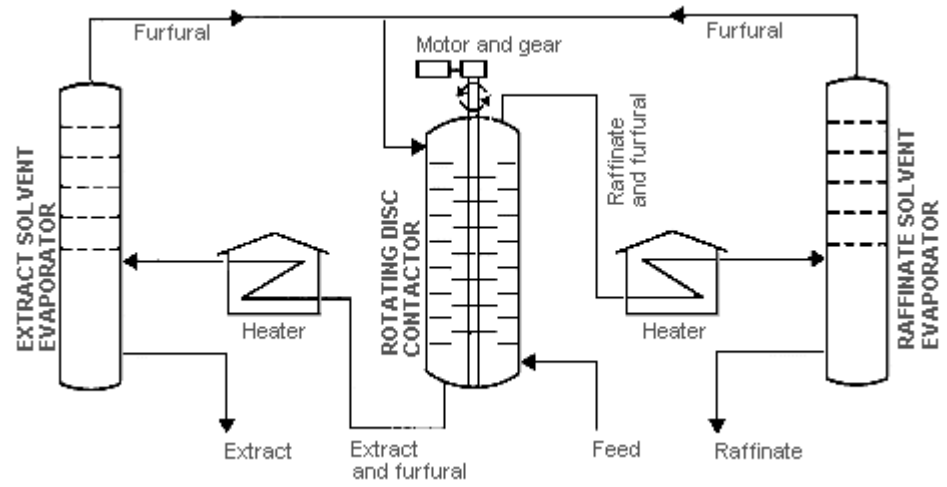
### C. SOLVENT EXTRACTION AND DEWAXING.

1. **Description.** Solvent treating is a widely used method of refining lubricating oils as well as a host of other refinery stocks. Since distillation (fractionation) separates petroleum products into groups only by their boiling-point ranges, impurities may remain. These include organic compounds containing sulfur, nitrogen, and oxygen; inorganic salts and dissolved metals; and soluble salts that were present in the crude feedstock. In addition, kerosene and distillates may have trace amounts of aromatics and naphthenes, and lubricating oil base-stocks may contain wax. Solvent refining processes including solvent extraction and solvent dewaxing usually remove these undesirables at intermediate refining stages or just before sending the product to storage.
2. **Solvent Extraction.**
  - a. The purpose of solvent extraction is to prevent corrosion, protect catalyst in subsequent processes, and improve finished products by removing unsaturated, aromatic hydrocarbons from lubricant and grease stocks. The solvent extraction process separates aromatics, naphthenes, and impurities from the product stream by dissolving or precipitation. The feedstock is first dried and then treated using a continuous countercurrent solvent treatment operation. In one type of process, the feedstock is washed with a liquid in which the substances to be removed are more soluble than in the desired resultant product. In another process, selected solvents are added to cause impurities to precipitate out of the product. In the adsorption process, highly porous solid materials collect liquid molecules on their surfaces.
  - b. The solvent is separated from the product stream by heating, evaporation, or fractionation, and residual trace amounts are subsequently removed from the raffinate by steam stripping or vacuum flashing. Electric precipitation may be used for separation of inorganic compounds. The solvent is then regenerated to be used again in the process.
  - c. The most widely used extraction solvents are phenol, furfural, and cresylic acid. Other solvents less frequently used are liquid sulfur dioxide, nitrobenzene, and 2,2'-dichloroethyl ether. The selection of specific processes and chemical agents depends on the nature of the feedstock being treated, the contaminants present, and the finished product requirements.

**TABLE IV:2-7. SOLVENT EXTRACTION PROCESS**

Feedstock From Process	Typical products . . . To
Naphthas, distillates, kerosene	Atm. Treating/ tower blending
	High octane gasoline . . . Storage
	Refined fuels . . . . . Treating and blending
	Spent agents . . . . . Treatment and blending

**FIGURE IV:2-10. AROMATICS EXTRACTION.**

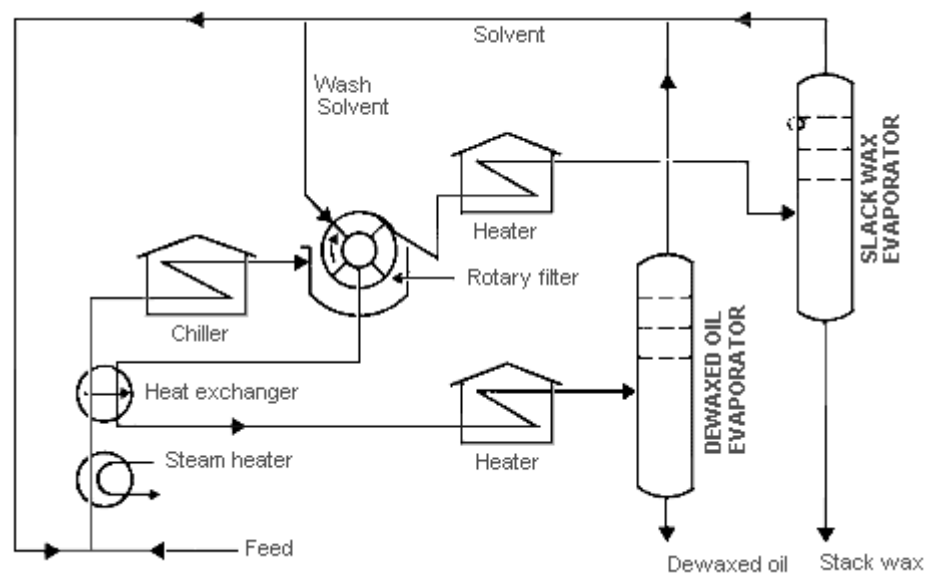


- Solvent Dewaxing.** Solvent dewaxing is used to remove wax from either distillate or residual basestocks at any stage in the refining process. There are several processes in use for solvent dewaxing, but all have the same general steps, which are: (1) mixing the feedstock with a solvent, (2) precipitating the wax from the mixture by chilling, and (3) recovering the solvent from the wax and dewaxed oil for recycling by distillation and steam stripping. Usually two solvents are used: toluene, which dissolves the oil and maintains fluidity at low temperatures, and methyl ethyl ketone (MEK), which dissolves little wax at low temperatures and acts as a wax precipitating agent. Other solvents that are sometimes used include benzene, methyl isobutyl ketone, propane, petroleum naphtha, ethylene dichloride, methylene chloride, and sulfur dioxide. In addition, there is a catalytic process used as an alternate to solvent dewaxing.

**TABLE IV:2-8. SOLVENT DEWAXING PROCESS**

Feedstock	From Process	Typical products . . . To
Lube basestock	Vacuum Treating tower	Dewaxed lubes . . . . . Hydrotreating Wax . . . . . Hydrotreating Spent agents . . . . . Treatment or recycle

**FIGURE IV:2-11. SOLVENT DEWAXING.**



**Note:** Diagrams in Figures IV:2-10, 11, 12, 13, 15, and 20 reproduced with permission from Shell International Petroleum Company.

#### 4. Health and Safety Considerations.

- a. **Fire Prevention and Protection.** Solvent treatment is essentially a closed process and, although operating pressures are relatively low, the potential exists for fire from a leak or spill contacting a source of ignition such as the drier or extraction heater. In solvent dewaxing, disruption of the vacuum will create a potential fire hazard by allowing air to enter the unit.
- b. **Health.** Because solvent extraction is a closed process, exposures are expected to be minimal under normal operating conditions. However, there is a potential for exposure to extraction solvents such as phenol, furfural, glycols, methyl ethyl ketone, amines, and other process chemicals. Safe work practices and/or the use of appropriate personal protective equipment may be needed for exposures to chemicals and other hazards such as noise and heat, and during repair, inspection, maintenance, and turnaround activities.

#### D. THERMAL CRACKING.

##### 1. Description.

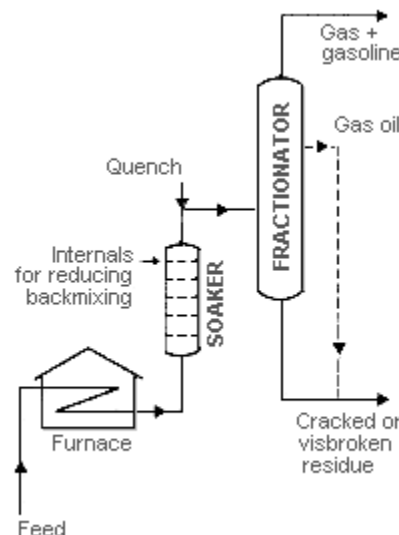
- a. Because the simple distillation of crude oil produces amounts and types of products that are not consistent with those required by the marketplace, subsequent refinery processes change the product mix by altering the molecular structure of the hydrocarbons. One of the ways of accomplishing this change is through "cracking," a process that breaks or cracks the heavier, higher boiling-point petroleum fractions into more valuable products such as gasoline, fuel oil, and gas oils. The two basic types of cracking are thermal cracking, using heat and pressure, and catalytic cracking.
  - b. The first thermal cracking process was developed around 1913. Distillate fuels and heavy oils were heated under pressure in large drums until they cracked into smaller molecules with better antiknock characteristics. However, this method produced large amounts of solid, unwanted coke. This early process has evolved into the following applications of thermal cracking: visbreaking, steam cracking, and coking.
2. **Visbreaking Process.** Visbreaking, a mild form of thermal cracking, significantly lowers the viscosity of heavy crude-oil residue without affecting the boiling point range. Residual from the

atmospheric distillation tower is heated (800°-950° F) at atmospheric pressure and mildly cracked in a heater. It is then quenched with cool gas oil to control overcracking, and flashed in a distillation tower. Visbreaking is used to reduce the pour point of waxy residues and reduce the viscosity of residues used for blending with lighter fuel oils. Middle distillates may also be produced, depending on product demand. The thermally cracked residue tar, which accumulates in the bottom of the fractionation tower, is vacuum flashed in a stripper and the distillate recycled.

**TABLE IV:2-9. VISBREAKING PROCESS.**

Feedstock From	Process	Typical products . . . . . To
Residual tower & Vacuum tower	Atmospheric Decompose	Gasoline or distillate . . . Hydrotreating Vapor . . . . . Hydrotreater Residue . . . . . Stripper or recycle Gases . . . . . Gas plant

**FIGURE IV:2-12. VISBREAKING.**



3. **Steam Cracking Process.** Steam cracking is a petrochemical process sometimes used in refineries to produce olefinic raw materials (e.g., ethylene) from various feedstock for petrochemicals manufacture. The feedstock range from ethane to vacuum gas oil, with heavier feeds giving higher yields of by-products such as naphtha. The most common feeds are ethane, butane, and naphtha. Steam cracking is carried out at temperatures of 1,500°-1,600° F, and at pressures slightly above atmospheric. Naphtha produced from steam cracking contains benzene, which is extracted prior to hydrotreating. Residual from steam cracking is sometimes blended into heavy fuels.
4. **Coking Processes.** Coking is a severe method of thermal cracking used to upgrade heavy residuals into lighter products or distillates. Coking produces straight-run gasoline (coker naphtha) and various middle-distillate fractions used as catalytic cracking feedstock. The process so completely reduces hydrogen that the residue is a form of carbon called "coke." The two most common processes are delayed coking and continuous (contact or fluid) coking. Three typical types of coke are obtained (sponge coke, honeycomb coke, and needle coke) depending upon the reaction mechanism, time, temperature, and the crude feedstock.
  - a. **Delayed Coking.** In delayed coking the heated charge (typically residuum from atmospheric distillation towers) is transferred to large coke drums which provide the long residence time needed to allow the cracking reactions to proceed to completion. Initially the heavy feedstock is fed to a

furnace which heats the residuum to high temperatures (900°-950° F) at low pressures (25-30 psi) and is designed and controlled to prevent premature coking in the heater tubes. The mixture is passed from the heater to one or more coker drums where the hot material is held approximately 24 hours (delayed) at pressures of 25-75 psi, until it cracks into lighter products. Vapors from the drums are returned to a fractionator where gas, naphtha, and gas oils are separated out. The heavier hydrocarbons produced in the fractionator are recycled through the furnace.

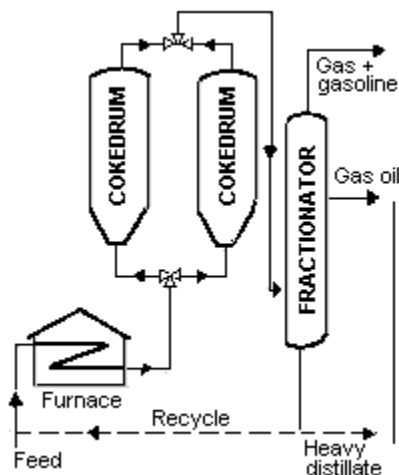
After the coke reaches a predetermined level in one drum, the flow is diverted to another drum to maintain continuous operation. The full drum is steamed to strip out uncracked hydrocarbons, cooled by water injection, and decoked by mechanical or hydraulic methods. The coke is mechanically removed by an auger rising from the bottom of the drum. Hydraulic decoking consists of fracturing the coke bed with high-pressure water ejected from a rotating cutter.

b. **Continuous Coking.** Continuous (contact or fluid) coking is a moving-bed process that operates at temperatures higher than delayed coking. In continuous coking, thermal cracking occurs by using heat transferred from hot, recycled coke particles to feedstock in a radial mixer, called a reactor, at a pressure of 50 psi. Gases and vapors are taken from the reactor, quenched to stop any further reaction, and fractionated. The reacted coke enters a surge drum and is lifted to a feeder and classifier where the larger coke particles are removed as product. The remaining coke is dropped into the preheater for recycling with feedstock. Coking occurs both in the reactor and in the surge drum. The process is automatic in that there is a continuous flow of coke and feedstock.

**TABLE IV: 2-10. COKING PROCESSES.**

Feedstock	From	Process	Typical products . . . To
Residual . . . .	Atmospheric & vacuum catalytic cracker	Decomposition	Naphtha, gasoline . . Distillation column,blending
Clarified oil . .	Catalytic cracker		Coke . . . . . Shipping, recycle
Tars . . . . .	Various units		Gas oil . . . . . Catalytic cracking
Wasteater (sour) . . . . .	Treatment		
Gases . . . . .	Gas plant		

**FIGURE IV:2-13. DELAYED COKING.**



**5. Health and Safety Considerations.**

a. **Fire Protection and Prevention.** Because thermal cracking is a closed process, the primary potential for fire is from leaks or releases of liquids, gases, or vapors reaching an ignition source such as a heater. The potential for fire is present in coking operations due to vapor or product leaks. Should coking temperatures get out of control, an exothermic reaction could occur within the coker.

b. **Safety.** In thermal cracking when sour crudes are processed, corrosion can occur where metal temperatures are between 450° and 900° F. Above 900° F coke forms a protective layer on the metal. The furnace, soaking drums, lower part of the tower, and high-temperature exchangers are usually subject to corrosion. Hydrogen sulfide corrosion in coking can also occur when temperatures are not properly controlled above 900° F.

Continuous thermal changes can lead to bulging and cracking of coke drum shells. In coking, temperature control must often be held within a 10°-20° F range, as high temperatures will produce coke that is too hard to cut out of the drum. Conversely, temperatures that are too low will result in a high asphaltic-content slurry. Water or steam injection may be used to prevent buildup of coke in delayed coker furnace tubes. Water must be completely drained from the coker, so as not to cause an explosion upon recharging with hot coke. Provisions for alternate means of egress from the working platform on top of coke drums are important in the event of an emergency.

c. **Health.** The potential exists for exposure to hazardous gases such as hydrogen sulfide and carbon monoxide, and trace polynuclear aromatics (PNA's) associated with coking operations. When coke is moved as a slurry, oxygen depletion may occur within confined spaces such as storage silos, since wet carbon will adsorb oxygen. Wastewater may be highly alkaline and contain oil, sulfides, ammonia, and/or phenol. The potential exists in the coking process for exposure to burns when handling hot coke or in the event of a steam-line leak, or from steam, hot water, hot coke, or hot slurry that may be expelled when opening cokers. Safe work practices and/or the use of appropriate personal protective equipment may be needed for exposures to chemicals and other hazards such as heat and noise, and during process sampling, inspection, maintenance, and turnaround activities. (Note: coke produced from petroleum is a different product from that generated in the steel-industry coking process.)

## E. CATALYTIC CRACKING.

### 1. Description.

a. Catalytic cracking breaks complex hydrocarbons into simpler molecules in order to increase the quality and quantity of lighter, more desirable products and decrease the amount of residuals. This process rearranges the molecular structure of hydrocarbon compounds to convert heavy hydrocarbon feedstock into lighter fractions such as kerosene, gasoline, LPG, heating oil, and petrochemical feedstock.

b. Catalytic cracking is similar to thermal cracking except that catalysts facilitate the conversion of the heavier molecules into lighter products. Use of a catalyst (a material that assists a chemical reaction but does not take part in it) in the cracking reaction increases the yield of improved-quality products under much less severe operating conditions than in thermal cracking. Typical temperatures are from 850°-950° F at much lower pressures of 10-20 psi. The catalysts used in refinery cracking units are typically solid materials (zeolite, aluminum hydrosilicate, treated bentonite clay, fuller's earth, bauxite, and silica-alumina) that come in the form of powders, beads, pellets or shaped materials called extrudites.

c. There are three basic functions in the catalytic cracking process:

- Reaction: Feedstock reacts with catalyst and cracks into different hydrocarbons;
- Regeneration: Catalyst is reactivated by burning off coke; and
- Fractionation: Cracked hydrocarbon stream is separated into various products.

d. The three types of catalytic cracking processes are fluid catalytic cracking (FCC), moving-bed catalytic cracking, and Thermoform catalytic cracking (TCC). The catalytic cracking process is very flexible, and operating parameters can be adjusted to meet changing product demand. In addition to cracking, catalytic activities include dehydrogenation, hydrogenation, and isomerization.

**TABLE IV: 2-11. CATALYTIC CRACKING PROCESS**

<b>Feedstock</b>	<b>From</b>	<b>Process</b>	<b>Typical products . . . . To</b>
Gas oils . . . .	Towers, coker visbreaker	Decomposition, alteration	Gasoline . . . . . Treater or blend Gases . . . . . Gas plant
Deasphalted oils . . . . .	Deasphalter		Middle distillates . . .Hydrotreat, blend, or recycle Petrochem feedstock . . Petrochem or other Residue . . . . . Residual fuel blend

**F. FLUID CATALYTIC CRACKING.**

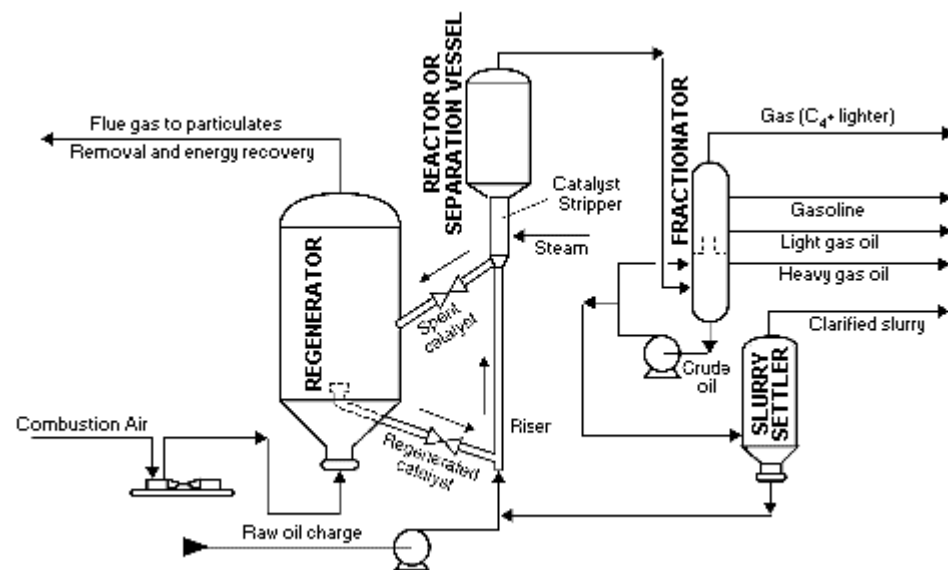
**1. Description.**

a. The most common process is FCC, in which the oil is cracked in the presence of a finely divided catalyst which is maintained in an aerated or fluidized state by the oil vapors. The fluid cracker consists of a catalyst section and a fractionating section that operate together as an integrated processing unit. The catalyst section contains the reactor and regenerator, which, with the standpipe and riser, forms the catalyst circulation unit. The fluid catalyst is continuously circulated between the reactor and the regenerator using air, oil vapors, and steam as the conveying media.

b. A typical FCC process involves mixing a preheated hydrocarbon charge with hot, regenerated catalyst as it enters the riser leading to the reactor. The charge is combined with a recycle stream within the riser, vaporized, and raised to reactor temperature (900° -1,000° F) by the hot catalyst. As the mixture travels up the riser, the charge is cracked at 10-30 psi. In the more modern FCC units, all cracking takes place in the riser. The "reactor" no longer functions as a reactor; it merely serves as a holding vessel for the cyclones. This cracking continues until the oil vapors are separated from the catalyst in the reactor cyclones. The resultant product stream (cracked product) is then charged to a fractionating column where it is separated into fractions, and some of the heavy oil is recycled to the riser.

c. Spent catalyst is regenerated to get rid of coke that collects on the catalyst during the process. Spent catalyst flows through the catalyst stripper to the regenerator, where most of the coke deposits burn off at the bottom where preheated air and spent catalyst are mixed. Fresh catalyst is added and worn-out catalyst removed to optimize the cracking process.

**FIGURE IV:2-14. FLUID CATALYTIC CRACKING.**



2. **Moving Bed Catalytic Cracking.** The moving-bed catalytic cracking process is similar to the FCC process. The catalyst is in the form of pellets that are moved continuously to the top of the unit by conveyor or pneumatic lift tubes to a storage hopper, then flow downward by gravity through the reactor, and finally to a regenerator. The regenerator and hopper are isolated from the reactor by steam seals. The cracked product is separated into recycle gas, oil, clarified oil, distillate, naphtha, and wet gas.
3. **Thermoform Catalytic Cracking.** In a typical thermoform catalytic cracking unit, the preheated feedstock flows by gravity through the catalytic reactor bed. The vapors are separated from the catalyst and sent to a fractionating tower. The spent catalyst is regenerated, cooled, and recycled. The flue gas from regeneration is sent to a carbon-monoxide boiler for heat recovery.
4. **Health and Safety Considerations.**
  - a. **Fire Prevention and Protection.** Liquid hydrocarbons in the catalyst or entering the heated combustion air stream should be controlled to avoid exothermic reactions. Because of the presence of heaters in catalytic cracking units, the possibility exists for fire due to a leak or vapor release. Fire protection including concrete or other insulation on columns and supports, or fixed water spray or fog systems where insulation is not feasible and in areas where firewater hose streams cannot reach, should be considered.

In some processes, caution must be taken to prevent explosive concentrations of catalyst dust during recharge or disposal. When unloading any coked catalyst, the possibility exists for iron sulfide fires. Iron sulfide will ignite spontaneously when exposed to air and therefore must be wetted with water to prevent it from igniting vapors. Coked catalyst may be either cooled below 120° F before it is dumped from the reactor, or dumped into containers that have been purged and inerted with nitrogen and then cooled before further handling.

- b. **Safety.** Regular sampling and testing of the feedstock, product, and recycle streams should be performed to assure that the cracking process is working as intended and that no contaminants have entered the process stream. Corrosives or deposits in the feedstock can foul gas compressors. Inspections of critical equipment including pumps, compressors, furnaces, and heat exchangers should be conducted as needed. When processing sour crude, corrosion may be expected where temperatures are below 900° F. Corrosion takes place where both liquid and vapor phases exist, and at areas subject to local cooling such as nozzles and platform supports.

When processing high-nitrogen feedstock, exposure to ammonia and cyanide may occur, subjecting

carbon steel equipment in the FCC overhead system to corrosion, cracking, or hydrogen blistering. These effects may be minimized by water wash or corrosion inhibitors. Water wash may also be used to protect overhead condensers in the main column subjected to fouling from ammonium hydrosulfide. Inspections should include checking for leaks due to erosion or other malfunctions such as catalyst buildup on the expanders, coking in the overhead feeder lines from feedstock residues, and other unusual operating conditions.

c. **Health.** Because the catalytic cracker is a closed system, there is normally little opportunity for exposure to hazardous substances during normal operations. The possibility exists of exposure to extremely hot (700° F) hydrocarbon liquids or vapors during process sampling or if a leak or release occurs. In addition, exposure to hydrogen sulfide and/or carbon monoxide gas may occur during a release of product or vapor.

Catalyst regeneration involves steam stripping and decoking, and produces fluid waste streams that may contain varying amounts of hydrocarbon, phenol, ammonia, hydrogen sulfide, mercaptan, and other materials depending upon the feedstock, crudes, and processes. Inadvertent formation of nickel carbonyl may occur in cracking processes using nickel catalysts, with resultant potential for hazardous exposures. Safe work practices and/or the use of appropriate personal protective equipment may be needed for exposures to chemicals and other hazards such as noise and heat; during process sampling, inspection, maintenance and turnaround activities; and when handling spent catalyst, recharging catalyst, or if leaks or releases occur.

## F. HYDROCRACKING.

### 1. Description.

a. Hydrocracking is a two-stage process combining catalytic cracking and hydrogenation, wherein heavier feedstocks are cracked in the presence of hydrogen to produce more desirable products. The process employs high pressure, high temperature, a catalyst, and hydrogen. Hydrocracking is used for feedstocks that are difficult to process by either catalytic cracking or reforming, since these feedstocks are characterized usually by a high polycyclic aromatic content and/or high concentrations of the two principal catalyst poisons, sulfur and nitrogen compounds.

b. The hydrocracking process largely depends on the nature of the feedstock and the relative rates of the two competing reactions, hydrogenation and cracking. Heavy aromatic feedstock is converted into lighter products under a wide range of very high pressures (1,000-2,000 psi) and fairly high temperatures (750° -1,500° F), in the presence of hydrogen and special catalysts. When the feedstock has a high paraffinic content, the primary function of hydrogen is to prevent the formation of polycyclic aromatic compounds. Another important role of hydrogen in the hydrocracking process is to reduce tar formation and prevent buildup of coke on the catalyst. Hydrogenation also serves to convert sulfur and nitrogen compounds present in the feedstock to hydrogen sulfide and ammonia.

c. Hydrocracking produces relatively large amounts of isobutane for alkylation feedstock. Hydrocracking also performs isomerization for pour-point control and smoke-point control, both of which are important in high-quality jet fuel.

### 2. Hydrocracking Process.

a. In the first stage, preheated feedstock is mixed with recycled hydrogen and sent to the first-stage reactor, where catalysts convert sulfur and nitrogen compounds to hydrogen sulfide and ammonia. Limited hydrocracking also occurs.

b. After the hydrocarbon leaves the first stage, it is cooled and liquefied and run through a hydrocarbon separator. The hydrogen is recycled to the feedstock. The liquid is charged to a fractionator. Depending on the products desired (gasoline components, jet fuel, and gas oil), the fractionator is run to cut out some portion of the first stage reactor out-turn. Kerosene-

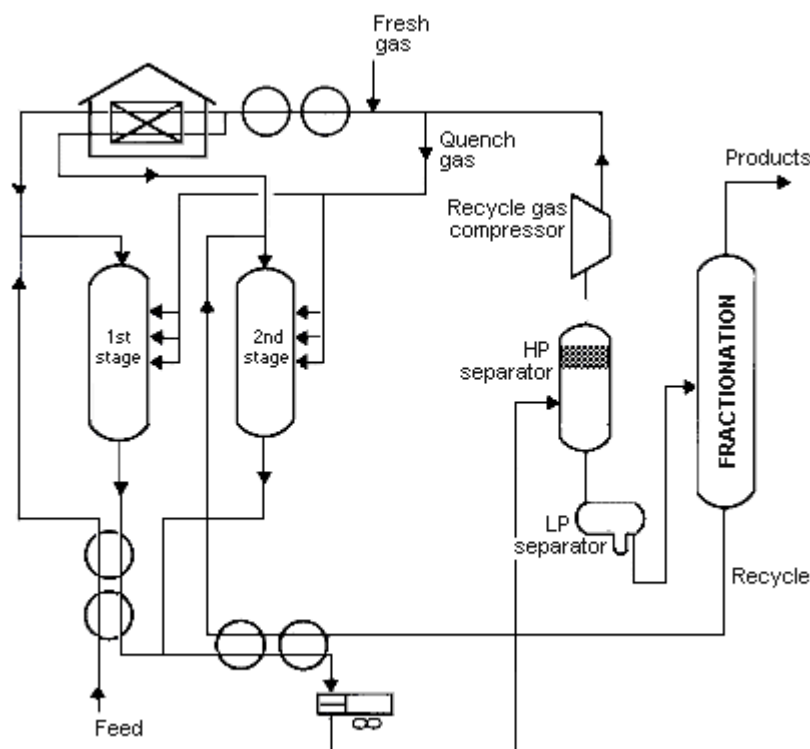
range material can be taken as a separate side-draw product or included in the fractionator bottoms with the gas oil.

c. The fractionator bottoms are again mixed with a hydrogen stream and charged to the second stage. Since this material has already been subjected to some hydrogenation, cracking, and reforming in the first stage, the operations of the second stage are more severe (higher temperatures and pressures). Like the outturn of the first stage, the second stage product is separated from the hydrogen and charged to the fractionator.

**TABLE IV: 2-12. HYDROCRACKING PROCESS.**

Feedstock From	Process	Typical products . . . . To
High pour point	Catalytic cracker, atmospheric & vacuum tower	Decomposition, hydrogenation, Kerosene, jet fuel . . . . Blending
Gas oil	Vacuum tower, coker	Gasoline, distillates . . Blending
Hydrogen	Reformer	Recycle, reformer gas . . Gas plant

**FIGURE IV:2-15. TWO-STAGE HYDROCRACKING.**



**3. Health and Safety Considerations.**

a. **Fire Prevention and Protection.** Because this unit operates at very high pressures and temperatures, control of both hydrocarbon leaks and hydrogen releases is important to

prevent fires. In some processes, care is needed to ensure that explosive concentrations of catalytic dust do not form during recharging.

b. **Safety.** Inspection and testing of safety relief devices are important due to the very high pressures in this unit. Proper process control is needed to protect against plugging reactor beds. Unloading coked catalyst requires special precautions to prevent iron sulfide-induced fires. The coked catalyst should either be cooled to below 120° F before dumping, or be placed in nitrogen-inerted containers until cooled.

Because of the operating temperatures and presence of hydrogen, the hydrogen-sulfide content of the feedstock must be strictly controlled to a minimum to reduce the possibility of severe corrosion. Corrosion by wet carbon dioxide in areas of condensation also must be considered. When processing high-nitrogen feedstock, the ammonia and hydrogen sulfide form ammonium hydrosulfide, which causes serious corrosion at temperatures below the water dew point. Ammonium hydrosulfide is also present in sour water stripping.

c. **Health.** Because this is a closed process, exposures are expected to be minimal under normal operating conditions. There is a potential for exposure to hydrocarbon gas and vapor emissions, hydrogen and hydrogen sulfide gas due to high-pressure leaks. Large quantities of carbon monoxide may be released during catalyst regeneration and changeover. Catalyst steam stripping and regeneration create waste streams containing sour water and ammonia. Safe work practices and/or the use of appropriate personal protective equipment may be needed for exposure to chemicals and other hazards such as noise and heat, during process sampling, inspection, maintenance, and turnaround activities, and when handling spent catalyst.

## G. CATALYTIC REFORMING.

### 1. Description.

a. Catalytic reforming is an important process used to convert low-octane naphthas into high-octane gasoline blending components called reformates. Reforming represents the total effect of numerous reactions such as cracking, polymerization, dehydrogenation, and isomerization taking place simultaneously. Depending on the properties of the naphtha feedstock (as measured by the paraffin, olefin, naphthene, and aromatic content) and catalysts used, reformates can be produced with very high concentrations of toluene, benzene, xylene, and other aromatics useful in gasoline blending and petrochemical processing. Hydrogen, a significant by-product, is separated from the reformat for recycling and use in other processes.

b. A catalytic reformer comprises a reactor section and a product-recovery section. More or less standard is a feed preparation section in which, by combination of hydrotreatment and distillation, the feedstock is prepared to specification. Most processes use platinum as the active catalyst. Sometimes platinum is combined with a second catalyst (bimetallic catalyst) such as rhenium or another noble metal.

c. There are many different commercial catalytic reforming processes including platforming, powerforming, ultraforming, and Thermoform catalytic reforming. In the platforming process, the first step is preparation of the naphtha feed to remove impurities from the naphtha and reduce catalyst degradation. The naphtha feedstock is then mixed with hydrogen, vaporized, and passed through a series of alternating furnace and fixed-bed reactors containing a platinum catalyst. The effluent from the last reactor is cooled and sent to a separator to permit removal of the hydrogen-rich gas stream from the top of the separator for recycling. The liquid product from the bottom of the separator is sent to a fractionator called a stabilizer (butanizer). It makes a bottom product called reformat; butanes and lighter go overhead and are sent to the saturated gas plant.

d. Some catalytic reformers operate at low pressure (50-200 psi), and others operate at high

pressures (up to 1,000 psi). Some catalytic reforming systems continuously regenerate the catalyst in other systems. One reactor at a time is taken off-stream for catalyst regeneration, and some facilities regenerate all of the reactors during turnarounds.

**2. Health and Safety Considerations.**

a. **Fire Prevention and Protection.** This is a closed system; however, the potential for fire exists should a leak or release of reformat gas or hydrogen occur.

b. **Safety.** Operating procedures should be developed to ensure control of hot spots during start-up. Safe catalyst handling is very important. Care must be taken not to break or crush the catalyst when loading the beds, as the small fines will plug up the reformer screens. Precautions against dust when regenerating or replacing catalyst should also be considered. Also, water wash should be considered where stabilizer fouling has occurred due to the formation of ammonium chloride and iron salts. Ammonium chloride may form in pretreater exchangers and cause corrosion and fouling. Hydrogen chloride from the hydrogenation of chlorine compounds may form acid or ammonium chloride salt.

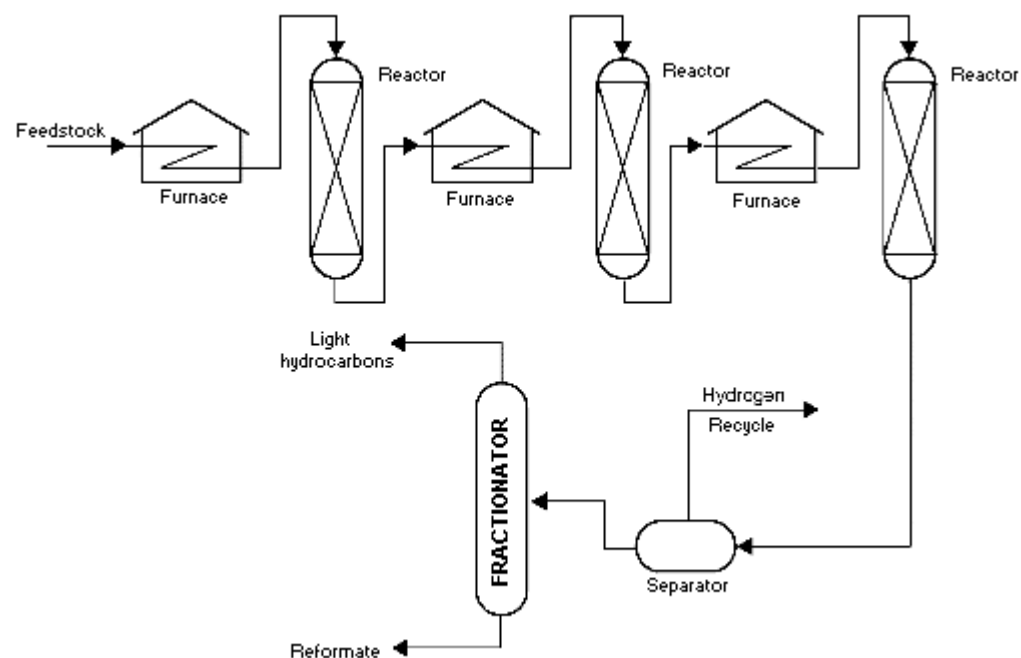
c. **Health.** Because this is a closed process, exposures are expected to be minimal under normal operating conditions. There is potential for exposure to hydrogen sulfide and benzene should a leak or release occur.

Small emissions of carbon monoxide and hydrogen sulfide may occur during regeneration of catalyst. Safe work practices and/or appropriate personal protective equipment may be needed for exposures to chemicals and other hazards such as noise and heat during testing, inspecting, maintenance and turnaround activities, and when handling regenerated or spent catalyst.

**TABLE IV: 2-13. CATALYTIC REFORMING PROCESS**

<b>Feedstock</b>	<b>From</b>	<b>Process</b>	<b>Typical products . . . . To</b>
Desulfurized naphtha	Coker	Rearrange, dehydrogenate	High octane gasoline . . Blending Aromatics . . . . Petrochemical
Naphthene- rich fractions	hydrocracker, hydrodesulfur		Hydrogen . . . . Recycle, hydrotreat, etc.
Straight-run naphtha	Atmospheric fractionator		Gas . . . . . Gas plant

**FIGURE IV:2-16. PLATFORMING PROCESS.**



#### H. CATALYTIC HYDROTREATING.

1. **Description.** Catalytic hydrotreating is a hydrogenation process used to remove about 90% of contaminants such as nitrogen, sulfur, oxygen, and metals from liquid petroleum fractions. These contaminants, if not removed from the petroleum fractions as they travel through the refinery processing units, can have detrimental effects on the equipment, the catalysts, and the quality of the finished product. Typically, hydrotreating is done prior to processes such as catalytic reforming so that the catalyst is not contaminated by untreated feedstock. Hydrotreating is also used prior to catalytic cracking to reduce sulfur and improve product yields, and to upgrade middle-distillate petroleum fractions into finished kerosene, diesel fuel, and heating fuel oils. In addition, hydrotreating converts olefins and aromatics to saturated compounds.
2. **Catalytic Hydrodesulfurization Process.** Hydrotreating for sulfur removal is called hydrodesulfurization. In a typical catalytic hydrodesulfurization unit, the feedstock is deaerated and mixed with hydrogen, preheated in a fired heater (600°-800° F) and then charged under pressure (up to 1,000 psi) through a fixed-bed catalytic reactor. In the reactor, the sulfur and nitrogen compounds in the feedstock are converted into H<sub>2</sub>S and NH<sub>3</sub>. The reaction products leave the reactor and after cooling to a low temperature enter a liquid/gas separator. The hydrogen-rich gas from the high-pressure separation is recycled to combine with the feedstock, and the low-pressure gas stream rich in H<sub>2</sub>S is sent to a gas treating unit where H<sub>2</sub>S is removed. The clean gas is then suitable as fuel for the refinery furnaces. The liquid stream is the product from hydrotreating and is normally sent to a stripping column for removal of H<sub>2</sub>S and other undesirable components. In cases where steam is used for stripping, the product is sent to a vacuum drier for removal of water. Hydrodesulfurized products are blended or used as catalytic reforming feedstock.
3. **Other Hydrotreating Processes.**
  - a. Hydrotreating processes differ depending upon the feedstock available and catalysts used.

Hydrotreating can be used to improve the burning characteristics of distillates such as kerosene. Hydrotreatment of a kerosene fraction can convert aromatics into naphthenes, which are cleaner-burning compounds.

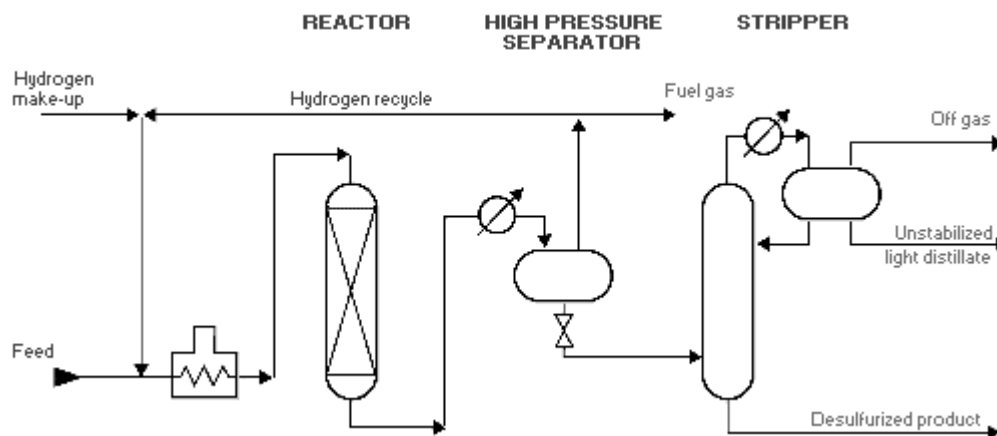
b. Lube-oil hydrotreating uses catalytic treatment of the oil with hydrogen to improve product quality. The objectives in mild lube hydrotreating include saturation of olefins and improvements in color, odor, and acid nature of the oil. Mild lube hydrotreating also may be used following solvent processing. Operating temperatures are usually below 600° F and operating pressures below 800 psi. Severe lube hydrotreating, at temperatures in the 600° - 750° F range and hydrogen pressures up to 3,000 psi, is capable of saturating aromatic rings, along with sulfur and nitrogen removal, to impart specific properties not achieved at mild conditions.

c. Hydrotreating also can be employed to improve the quality of pyrolysis gasoline (pygas), a by-product from the manufacture of ethylene. Traditionally, the outlet for pygas has been motor gasoline blending, a suitable route in view of its high octane number. However, only small portions can be blended untreated owing to the unacceptable odor, color, and gum-forming tendencies of this material. The quality of pygas, which is high in diolefin content, can be satisfactorily improved by hydrotreating, whereby conversion of diolefins into mono-olefins provides an acceptable product for motor gas blending.

**TABLE IV: 2-14 HYDRODESULFURIZATION PROCESS**

Feedstock From	Process	Typical products . . To
Naphthas, distillates	Atmospheric Treating, & vacuum tower,	Naphtha . . . . . Blending
sour gas	catalytic &	Hydrogen . . . . . Recycle
oil,	thermal	Distillates . . . . . Blending
residuals	cracker	H <sub>2</sub> S, ammonia . . Sulfure plant, treater
		Gas . . . . . Gas plant

**FIGURE IV:2-17. DISTILLATE HYDRODESULFURIZATION.**



**4. Health and Safety Considerations.**

a. **Fire Prevention and Protection.** The potential exists for fire in the event of a leak or release of product or hydrogen gas.

b. **Safety.** Many processes require hydrogen generation to provide for a continuous supply.

Because of the operating temperatures and presence of hydrogen, the hydrogen sulfide content of the feedstock must be strictly controlled to a minimum to reduce corrosion. Hydrogen chloride may form and condense as hydrochloric acid in the lower-temperature parts of the unit. Ammonium hydrosulfide may form in high-temperature, high-pressure units. Excessive contact time and/or temperature will create coking. Precautions need to be taken when unloading coked catalyst from the unit to prevent iron sulfide fires. The coked catalyst should be cooled to below 120° F before removal, or dumped into nitrogen-inerted bins where it can be cooled before further handling. Special antifoam additives may be used to prevent catalyst poisoning from silicone carryover in the coker feedstock.

c. **Health.** Because this is a closed process, exposures are expected to be minimal under normal operating conditions. There is a potential for exposure to hydrogen sulfide or hydrogen gas in the event of a release, or to ammonia should a sour-water leak or spill occur. Phenol also may be present if high boiling-point feedstocks are processed. Safe work practices and/or appropriate personal protective equipment may be needed for exposures to chemicals and other hazards such as noise and heat; during process sampling, inspection, maintenance, and turnaround activities; and when handling amine or exposed to catalyst.

## I. ISOMERIZATION.

### 1. Description.

a. Isomerization converts n-butane, n-pentane and n-hexane into their respective isoparaffins of substantially higher octane number. The straight-chain paraffins are converted to their branched-chain counterparts whose component atoms are the same but are arranged in a different geometric structure. Isomerization is important for the conversion of n-butane into isobutane, to provide additional feedstock for alkylation units, and the conversion of normal pentanes and hexanes into higher branched isomers for gasoline blending. Isomerization is similar to catalytic reforming in that the hydrocarbon molecules are rearranged, but unlike catalytic reforming, isomerization just converts normal paraffins to isoparaffins.

b. There are two distinct isomerization processes, butane (C<sub>4</sub>) and pentane/hexane (C<sub>5</sub>/C<sub>6</sub>). Butane isomerization produces feedstock for alkylation. Aluminum chloride catalyst plus hydrogen chloride are universally used for the low-temperature processes. Platinum or another metal catalyst is used for the higher-temperature processes. In a typical low-temperature process, the feed to the isomerization plant is n-butane or mixed butanes mixed with hydrogen (to inhibit olefin formation) and passed to the reactor at 230°-340° F and 200-300 psi. Hydrogen is flashed off in a high-pressure separator and the hydrogen chloride removed in a stripper column. The resultant butane mixture is sent to a fractionator (deisobutanizer) to separate n-butane from the isobutane product.

c. Pentane/hexane isomerization increases the octane number of the light gasoline components n-pentane and n-hexane, which are found in abundance in straight-run gasoline. In a typical C<sub>5</sub>/C<sub>6</sub> isomerization process, dried and desulfurized feedstock is mixed with a small amount of organic chloride and recycled hydrogen, and then heated to reactor temperature. It is then passed over supported-metal catalyst in the first reactor where benzene and olefins are hydrogenated. The feed next goes to the isomerization reactor where the paraffins are catalytically isomerized to isoparaffins. The reactor effluent is then cooled and subsequently separated in the product separator into two streams: a liquid product (isomerate) and a recycle hydrogen-gas stream. The isomerate is washed (caustic and water), acid stripped, and stabilized before going to storage.

**TABLE IV: 2-15. ISOMERIZATION PROCESSES**

--

Feedstock	From	Process	Typical products . . .	To
n-Butane	Various	Rearrangement	Isobutane . . . . .	Alkylation
n-Pentane	Processes		Isopentane . . . . .	Blending
n-Hexane			Isohexane . . . . .	Blending
			Gas . . . . .	Gas Plant

FIGURE IV:2-18. C<sub>4</sub> ISOMERIZATION.

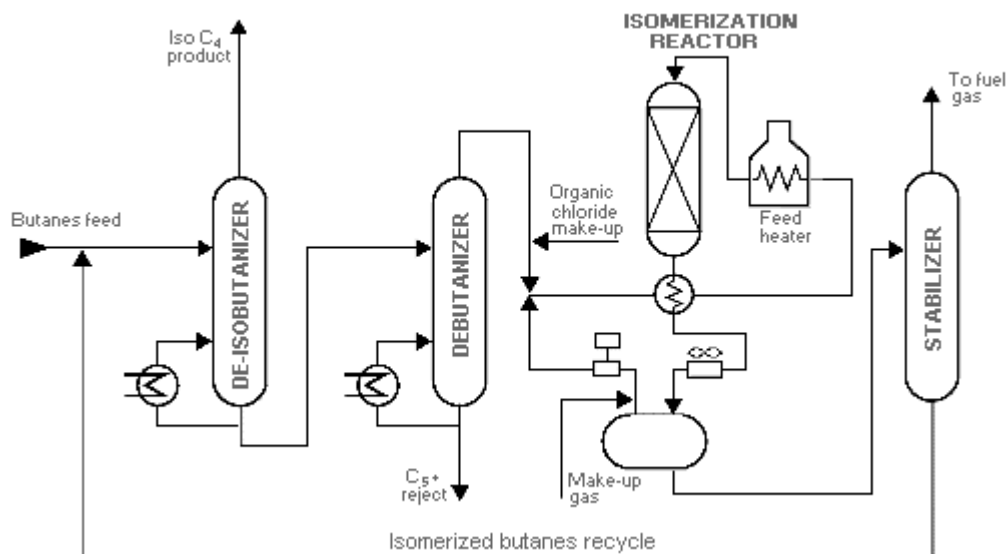
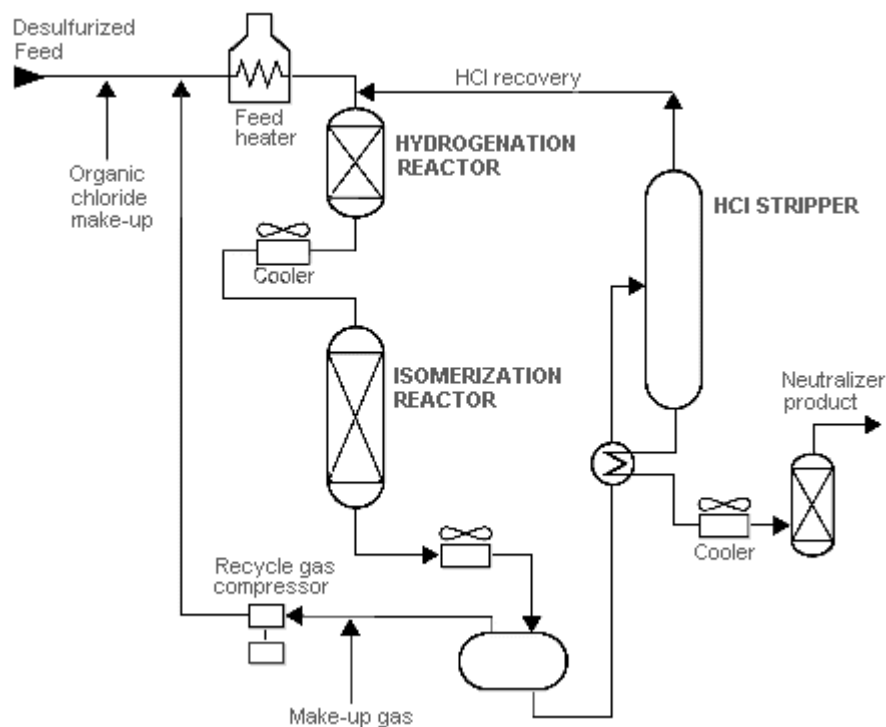


FIGURE IV:2-19. C<sub>5</sub> AND C<sub>6</sub> ISOMERIZATION.



## 2. Safety and Health Considerations.

- a. **Fire Protection and Prevention.** Although this is a closed process, the potential for a fire exists should a release or leak contact a source of ignition such as the heater.
- b. **Safety.** If the feedstock is not completely dried and desulfurized, the potential exists for acid formation leading to catalyst poisoning and metal corrosion. Water or steam must not be allowed to enter areas where hydrogen chloride is present. Precautions are needed to prevent HCl from entering sewers and drains.
- c. **Health.** Because this is a closed process, exposures are expected to be minimal during normal operating conditions. There is a potential for exposure to hydrogen gas, hydrochloric acid, and hydrogen chloride and to dust when solid catalyst is used. Safe work practices and/or appropriate personal protective equipment may be needed for exposures to chemicals and other hazards such as heat and noise, and during process sampling, inspection, maintenance, and turnaround activities.

## K. POLYMERIZATION.

### 1. Description.

- a. Polymerization in the petroleum industry is the process of converting light olefin gases including ethylene, propylene, and butylene into hydrocarbons of higher molecular weight and higher octane number that can be used as gasoline blending stocks. Polymerization combines two or more identical olefin molecules to form a single molecule with the same elements in the same proportions as the original molecules. Polymerization may be accomplished thermally or in the presence of a catalyst at lower temperatures.
- b. The olefin feedstock is pretreated to remove sulfur and other undesirable compounds. In the catalytic process the feedstock is either passed over a solid phosphoric acid catalyst or comes in contact with liquid phosphoric acid, where an exothermic polymeric reaction occurs. This reaction requires cooling water and the injection of cold feedstock into the reactor to control temperatures between 300° and 450° F at pressures from 200 psi to 1,200 psi. The reaction products leaving the reactor are sent to stabilization and/or fractionator systems to separate saturated and unreacted gases from the polymer gasoline product.

NOTE: In the petroleum industry, polymerization is used to indicate the production of gasoline components, hence the term "polymer" gasoline. Furthermore, it is not essential that only one type of monomer be involved. If unlike olefin molecules are combined, the process is referred to as "copolymerization." Polymerization in the true sense of the word is normally prevented, and all attempts are made to terminate the reaction at the dimer or trimer (three monomers joined together) stage. However, in the petrochemical section of a refinery, polymerization, which results in the production of, for instance, polyethylene, is allowed to proceed until materials of the required high molecular weight have been produced.

### 2. Safety and Health Considerations.

- a. **Fire prevention and Protection.** Polymerization is a closed process where the potential for a fire exists due to leaks or releases reaching a source of ignition.
- b. **Safety.** The potential for an uncontrolled exothermic reaction exists should loss of cooling water occur. Severe corrosion leading to equipment failure will occur should water make contact with the phosphoric acid, such as during water washing at shutdowns. Corrosion may

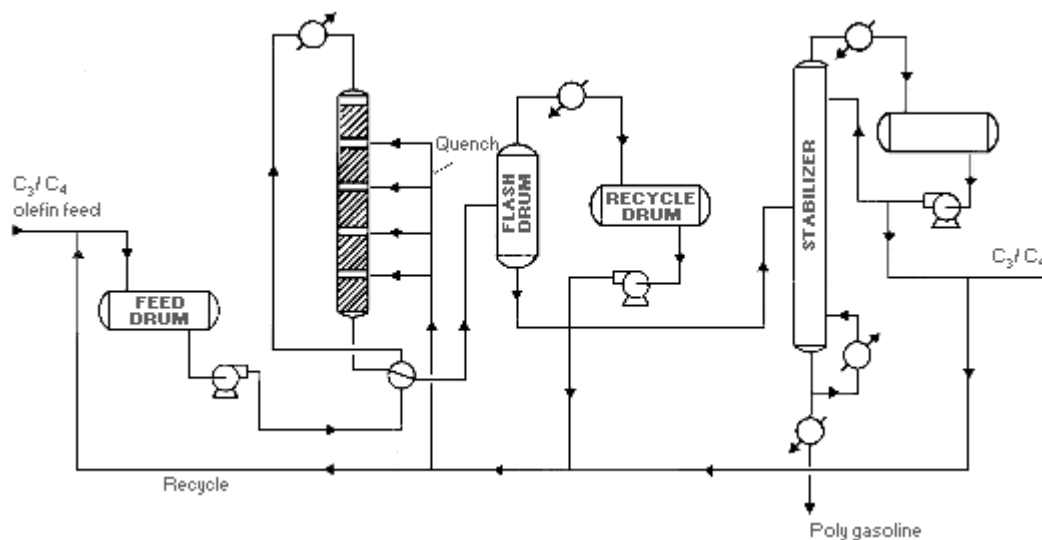
also occur in piping manifolds, reboilers, exchangers, and other locations where acid may settle out.

c. **Health.** Because this is a closed system, exposures are expected to be minimal under normal operating conditions. There is a potential for exposure to caustic wash (sodium hydroxide), to phosphoric acid used in the process or washed out during turnarounds, and to catalyst dust. Safe work practices and/or appropriate personal protective equipment may be needed for exposures to chemicals and other hazards such as noise and heat, and during process sampling, inspection, maintenance, and turnaround activities.

**TABLE IV: 2-16. POLYMERIZATION PROCESS**

Feedstock From	Process	Typical products . . . . . To
Olefins	Cracking processes	Unification High octane naphtha . . . Gasoline blending Petrochem. feedstock . . . Petrochemical Liquefied petro. gas . . . Storage

**FIGURE IV:2-20. POLYMERIZATION PROCESS.**



**L. ALKYLATION.**

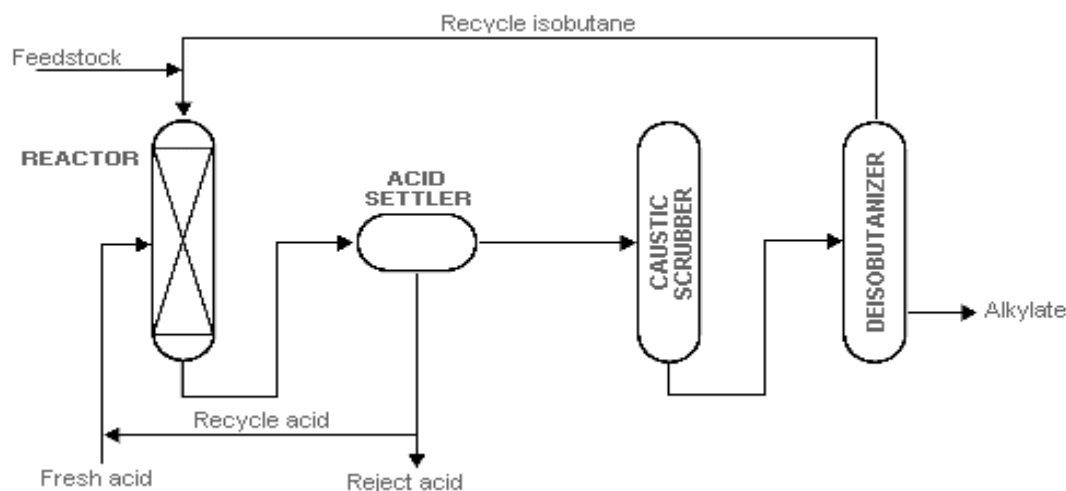
1. **Description.** Alkylation combines low-molecular-weight olefins (primarily a mixture of propylene and butylene) with isobutene in the presence of a catalyst, either sulfuric acid or hydrofluoric acid. The product is called alkylate and is composed of a mixture of high-octane, branched-chain paraffinic hydrocarbons. Alkylate is a premium blending stock because it has exceptional antiknock properties and is clean burning. The octane number of the alkylate depends mainly upon the kind of olefins used and upon operating conditions.
2. **Sulfuric Acid Alkylation Process.**
  - a. In cascade type sulfuric acid (H<sub>2</sub>SO<sub>4</sub>) alkylation units, the feedstock (propylene, butylene, amylene, and fresh isobutane) enters the reactor and contacts the concentrated sulfuric acid catalyst (in concentrations of 85% to 95% for good operation and to minimize corrosion). The reactor is divided into zones, with olefins fed through distributors to each zone, and the sulfuric acid and isobutanes flowing over baffles from zone to zone.

- b. The reactor effluent is separated into hydrocarbon and acid phases in a settler, and the acid is returned to the reactor. The hydrocarbon phase is hot-water washed with caustic for pH control before being successively depropanized, deisobutanized, and debutanized. The alkylate obtained from the deisobutanizer can then go directly to motor-fuel blending or be rerun to produce aviation-grade blending stock. The isobutane is recycled to the feed.
3. **Hydrofluoric Acid Alkylation Process.** Phillips and UOP are the two common types of hydrofluoric acid alkylation processes in use. In the Phillips process, olefin and isobutane feedstock are dried and fed to a combination reactor/settler system. Upon leaving the reaction zone, the reactor effluent flows to a settler (separating vessel) where the acid separates from the hydrocarbons. The acid layer at the bottom of the separating vessel is recycled. The top layer of hydrocarbons (hydrocarbon phase), consisting of propane, normal butane, alkylate, and excess (recycle) isobutane, is charged to the main fractionator, the bottom product of which is motor alkylate. The main fractionator overhead, consisting mainly of propane, isobutane, and HF, goes to a depropanizer. Propane with trace amount of HF goes to an HF stripper for HF removal and is then catalytically defluorinated, treated, and sent to storage. Isobutane is withdrawn from the main fractionator and recycled to the reactor/settler, and alkylate from the bottom of the main fractionator is sent to product blending.
  4. The UOP process uses two reactors with separate settlers. Half of the dried feedstock is charged to the first reactor, along with recycle and makeup isobutane. The reactor effluent then goes to its settler, where the acid is recycled and the hydrocarbon charged to the second reactor. The other half of the feedstock also goes to the second reactor, with the settler acid being recycled and the hydrocarbons charged to the main fractionator. Subsequent processing is similar to the Phillips process. Overhead from the main fractionator goes to a depropanizer. Isobutane is recycled to the reaction zone and alkylate is sent to product blending.

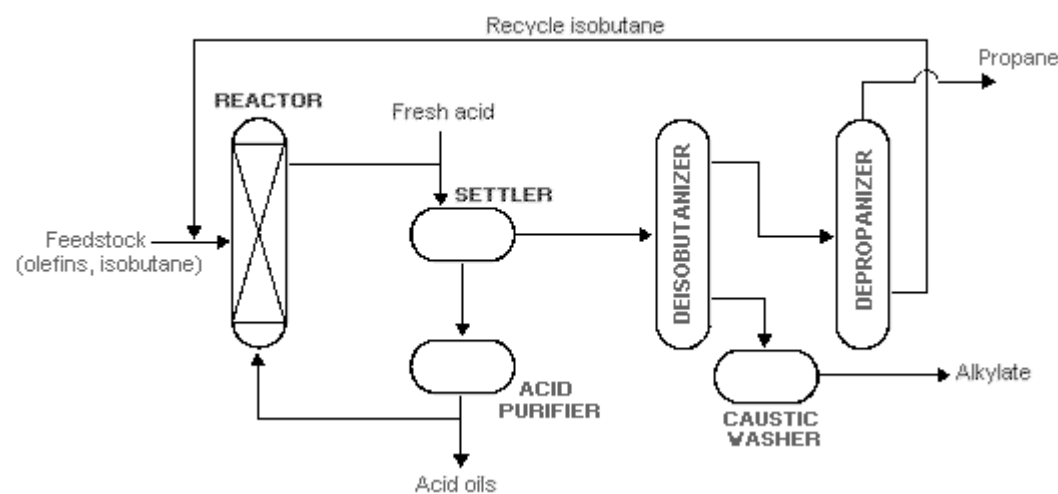
**TABLE IV: 2-17. ALKYLATION PROCESS**

Feedstock From	Process	Typical products . . . .	To
Petroleum gas	Distillation or cracking	Unification High octane gasoline . .	Blending
Olefins	Cat. or hydro cracking	n-Butane & propane . . .	Stripper or blender
Isobutane	Isomerization		

**FIGURE IV:2-21. SULFURIC ACID ALKYLATION.**



**FIGURE IV:2-22. HYDROGEN FLUORIDE ALKYLATION.**



## 5. Health and Safety Considerations.

a. **Fire Protection and Prevention.** Alkylation units are closed processes; however, the potential exists for fire should a leak or release occur that allows product or vapor to reach a source of ignition.

b. **Safety.** Sulfuric acid and hydrofluoric acid are potentially hazardous chemicals. Loss of coolant water, which is needed to maintain process temperatures, could result in an upset. Precautions are necessary to ensure that equipment and materials that have been in contact with acid are handled carefully and are thoroughly cleaned before they leave the process area or refinery. Immersion wash vats are often provided for neutralization of equipment that has come into contact with hydrofluoric acid. Hydrofluoric acid units should be thoroughly drained and chemically cleaned prior to turnarounds and entry to remove all traces of iron fluoride and hydrofluoric acid. Following shutdown, where water has been used the unit should be thoroughly dried before hydrofluoric acid is introduced.

Leaks, spills, or releases involving hydrofluoric acid or hydrocarbons containing hydrofluoric acid can be extremely hazardous. Care during delivery and unloading of acid is essential. Process unit containment by curbs, drainage, and isolation so that effluent can be neutralized before release to the sewer system is considered. Vents can be routed to soda-ash scrubbers

to neutralize hydrogen fluoride gas or hydrofluoric acid vapors before release. Pressure on the cooling water and steam side of exchangers should be kept below the minimum pressure on the acid service side to prevent water contamination.

Some corrosion and fouling in sulfuric acid units may occur from the breakdown of sulfuric acid esters or where caustic is added for neutralization. These esters can be removed by fresh acid treating and hot-water washing. To prevent corrosion from hydrofluoric acid, the acid concentration inside the process unit should be maintained above 65% and moisture below 4%.

c. **Health.** Because this is a closed process, exposures are expected to be minimal during normal operations. There is a potential for exposure should leaks, spills, or releases occur. Sulfuric acid and (particularly) hydrofluoric acid are potentially hazardous chemicals. Special precautionary emergency preparedness measures and protection appropriate to the potential hazard and areas possibly affected need to be provided. Safe work practices and appropriate skin and respiratory personal protective equipment are needed for potential exposures to hydrofluoric and sulfuric acids during normal operations such as reading gauges, inspecting, and process sampling, as well as during emergency response, maintenance, and turnaround activities. Procedures should be in place to ensure that protective equipment and clothing worn in hydrofluoric acid activities are decontaminated and inspected before reissue. Appropriate personal protection for exposure to heat and noise also may be required.

#### M. SWEETENING AND TREATING PROCESSES.

##### 1. Description.

a. Treating is a means by which contaminants such as organic compounds containing sulfur, nitrogen, and oxygen; dissolved metals and inorganic salts; and soluble salts dissolved in emulsified water are removed from petroleum fractions or streams. Petroleum refiners have a choice of several different treating processes, but the primary purpose of the majority of them is the elimination of unwanted sulfur compounds. A variety of intermediate and finished products, including middle distillates, gasoline, kerosene, jet fuel, and sour gases are dried and sweetened. Sweetening, a major refinery treatment of gasoline, treats sulfur compounds (hydrogen sulfide, thiophene and mercaptan) to improve color, odor, and oxidation stability. Sweetening also reduces concentrations of carbon dioxide.

b. Treating can be accomplished at an intermediate stage in the refining process, or just before sending the finished product to storage. Choices of a treating method depend on the nature of the petroleum fractions, amount and type of impurities in the fractions to be treated, the extent to which the process removes the impurities, and end-product specifications. Treating materials include acids, solvents, alkalis, oxidizing, and adsorption agents.

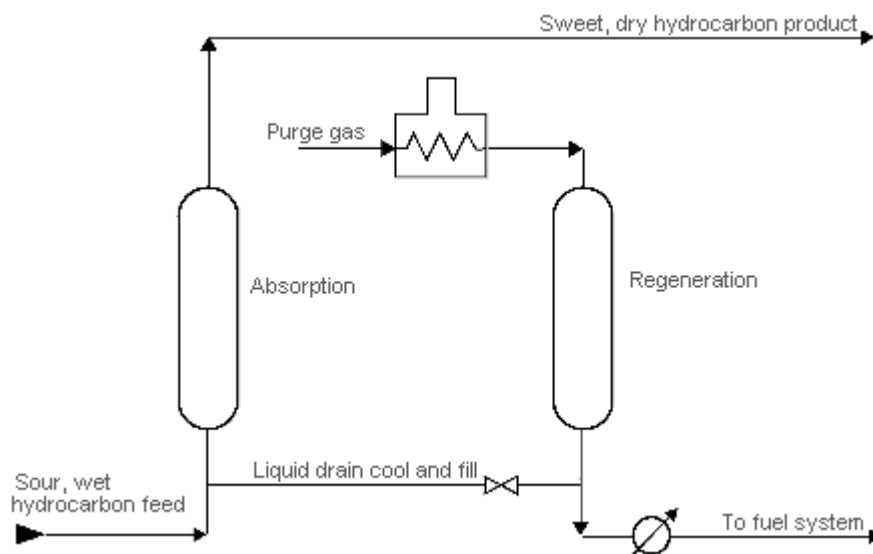
2. **Acid, Caustic, or Clay Treating.** Sulfuric acid is the most commonly used acid treating process. Sulfuric acid treating results in partial or complete removal of unsaturated hydrocarbons, sulfur, nitrogen, and oxygen compounds, and resinous and asphaltic compounds. It is used to improve the odor, color, stability, carbon residue, and other properties of the oil. Clay/lime treatment of acid-refined oil removes traces of asphaltic materials and other compounds improving product color, odor, and stability. Caustic treating with sodium (or potassium) hydroxide is used to improve odor and color by removing organic acids (naphthenic acids, phenols) and sulfur compounds (mercaptans, H<sub>2</sub>S) by a caustic wash. By combining caustic soda solution with various solubility promoters (e.g., methyl alcohol and cresols), up to 99% of all mercaptans as well as oxygen and nitrogen compounds can be dissolved from petroleum fractions.
3. **Drying and Sweetening.** Feedstocks from various refinery units are sent to gas treating plants where butanes and butenes are removed for use as alkylation feedstock, heavier components are sent to gasoline blending, propane is recovered for LPG, and propylene is

removed for use in petrochemicals. Some mercaptans are removed by water-soluble chemicals that react with the mercaptans. Caustic liquid (sodium hydroxide), amine compounds (diethanolamine) or fixed-bed catalyst sweetening also may be used. Drying is accomplished by the use of water absorption or adsorption agents to remove water from the products. Some processes simultaneously dry and sweeten by adsorption on molecular sieves.

**TABLE IV: 2-18. SWEETENING AND TREATING PROCESSES.**

Feedstock	From Process	Typical products . . . . .	To
Gases, finished products, intermediates	Various Treatment	Butane & butene . . . . Propane, distillates . . . Gasoline . . . . . Propylene . . . . .	Alkylation Storage Blending Petrochemical

**FIGURE IV:2-23. MOLECULAR SIEVE DRYING AND SWEETENING.**



4. **Sulfur Recovery.** Sulfur recovery converts hydrogen sulfide in sour gases and hydrocarbon streams to elemental sulfur. The most widely used recovery system is the Claus process, which uses both thermal and catalytic-conversion reactions. A typical process produces elemental sulfur by burning hydrogen sulfide under controlled conditions. Knockout pots are used to remove water and hydrocarbons from feed gas streams. The gases are then exposed to a catalyst to recover additional sulfur. Sulfur vapor from burning and conversion is condensed and recovered.
5. **Hydrogen Sulfide Scrubbing.** Hydrogen sulfide scrubbing is a common treating process in which the hydrocarbon feedstock is first scrubbed to prevent catalyst poisoning. Depending on the feedstock and the nature of contaminants, desulfurization methods vary from ambient temperature-activated charcoal absorption to high-temperature catalytic hydrogenation followed by zinc oxide treating.
6. **Health and Safety Considerations.**
  - a. **Fire Protection and Prevention.** The potential exists for fire from a leak or release of feedstock or product. Sweetening processes use air or oxygen. If excess oxygen enters these

processes, it is possible for a fire to occur in the settler due to the generation of static electricity, which acts as the ignition source.

b. **Health.** Because these are closed processes, exposures are expected to be minimal under normal operating conditions. There is a potential for exposure to hydrogen sulfide, caustic (sodium hydroxide), spent caustic, spent catalyst (Merox), catalyst dust and sweetening agents (sodium carbonate and sodium bicarbonate). Safe work practices and/or appropriate personal protective equipment may be needed for exposures to chemicals and other hazards such as noise and heat, and during process sampling, inspection, maintenance, and turnaround activities.

**N. UNSATURATED GAS PLANTS.**

1. **Description.** Unsaturated (unsat) gas plants recover light hydrocarbons (C<sub>3</sub> and C<sub>4</sub> olefins) from wet gas streams from the FCC, TCC, and delayed coker overhead accumulators or fractionation receivers. In a typical unsat gas plant, the gases are compressed and treated with amine to remove hydrogen sulfide either before or after they are sent to a fractionating absorber where they are mixed into a concurrent flow of debutanized gasoline. The light fractions are separated by heat in a reboiler, the offgas is sent to a sponge absorber, and the bottoms are sent to a debutanizer. A portion of the debutanized hydrocarbon is recycled, with the balance sent to the splitter for separation. The overhead gases go to a depropanizer for use as alkylation unit feedstock.

**TABLE IV: 2-19. UNSAT GAS PLANT PROCESS.**

Feedstock From	Process	Typical products . . . To
Gas Oils	FCC, TCC, delayed coker	Treatment Gasoline . . . . . Recycle or treating Gases . . . . . Alkylation

2. **Health and Safety Considerations.**

a. **Fire Prevention and Protection.** The potential of a fire exists should spills, releases, or vapors reach a source of ignition.

b. **Safety.** In unsat gas plants handling FCC feedstock, the potential exists for corrosion from moist hydrogen sulfide and cyanides. When feedstocks are from the delayed coker or the TCC, corrosion from hydrogen sulfide and deposits in the high pressure sections of gas compressors from ammonium compounds is possible.

c. **Health.** Because these are closed processes, exposures are expected to be minimal under normal operating conditions. There is a potential for exposures to amine compounds such as monoethanolamine (MEA), diethanolamine (DEA) and methyldiethanolamine (MDEA) and hydrocarbons. Safe work practices and/or appropriate personal protective equipment may be needed for exposures to chemicals and other hazards such as noise and heat, and during process sampling, inspection, maintenance, and turnaround activities.

**O. AMINE PLANTS.**

1. **Description.** Amine plants remove acid contaminants from sour gas and hydrocarbon streams. In amine plants, gas and liquid hydrocarbon streams containing carbon dioxide and/or hydrogen sulfide are charged to a gas absorption tower or liquid contactor where the

acid contaminants are absorbed by counterflowing amine solutions (i.e., MEA, DEA, MDEA). The stripped gas or liquid is removed overhead, and the amine is sent to a regenerator. In the regenerator, the acidic components are stripped by heat and reboiling action and disposed of, and the amine is recycled.

## 2. Health and Safety Considerations.

a. **Fire Protection and Prevention.** The potential for fire exists where a spill or leak could reach a source of ignition.

b. **Safety.** To minimize corrosion, proper operating practices should be established and regenerator bottom and reboiler temperatures controlled. Oxygen should be kept out of the system to prevent amine oxidation.

c. **Health.** Because this is a closed process, exposures are expected to be minimal during normal operations. There is potential for exposure to amine compounds (i.e. monoethanolamine, diethanolamine, methyldiethanolamine), hydrogen sulfide and carbon dioxide. Safe work practices and/or appropriate personal protective equipment may be needed for exposures to chemicals and other hazards such as noise and heat, and during process sampling, inspection, maintenance and turnaround activities.

## P. SATURATE GAS PLANTS.

1. **Description.** Saturate (sat) gas plants separate refinery gas components including butanes for alkylation, pentanes for gasoline blending, LPG's for fuel, and ethane for petrochemicals. Because sat gas processes depend on the feedstock and product demand, each refinery uses different systems, usually absorption-fractionation or straight fractionation. In absorption-fractionation, gases and liquids from various refinery units are fed to an absorber-deethanizer where C<sub>2</sub> and lighter fractions are separated from heavier fractions by lean oil absorption and removed for use as fuel gas or petrochemical feed. The heavier fractions are stripped and sent to a debutanizer, and the lean oil is recycled back to the absorber-deethanizer. C<sub>3</sub>/C<sub>4</sub> is separated from pentanes in the debutanizer, scrubbed to remove hydrogen sulfide, and fed to a splitter where propane and butane are separated. In fractionation sat gas plants, the absorption stage is eliminated.

## 2. Health and Safety Considerations.

a. **Fire Protection and Prevention.** There is potential for fire if a leak or release reaches a source of ignition such as the unit reboiler.

b. **Safety.** Corrosion could occur from the presence of hydrogen sulfide, carbon dioxide, and other compounds as a result of prior treating. Streams containing ammonia should be dried before processing. Antifouling additives may be used in absorption oil to protect heat exchangers. Corrosion inhibitors may be used to control corrosion in overhead systems.

c. **Health.** Because this is a closed process, exposures are expected to be minimal during normal operations. There is potential for exposure to hydrogen sulfide, carbon dioxide, and other products such as diethanolamine or sodium hydroxide carried over from prior treating. Safe work practices and/or appropriate personal protective equipment may be needed for exposures to chemicals and other hazards such as noise and heat, and during process sampling, inspection, maintenance, and turnaround activities.

## Q. ASPHALT PRODUCTION.

1. **Description.**

- a. Asphalt is a portion of the residual fraction that remains after primary distillation operations. It is further processed to impart characteristics required by its final use. In vacuum distillation, generally used to produce road-tar asphalt, the residual is heated to about 750° F and charged to a column where vacuum is applied to prevent cracking.
- b. Asphalt for roofing materials is produced by air blowing. Residual is heated in a pipe still almost to its flash point and charged to a blowing tower where hot air is injected for a predetermined time. The dehydrogenization of the asphalt forms hydrogen sulfide, and the oxidation creates sulfur dioxide. Steam, used to blanket the top of the tower to entrain the various contaminants, is then passed through a scrubber to condense the hydrocarbons.
- c. A third process used to produce asphalt is solvent deasphalting. In this extraction process, which uses propane (or hexane) as a solvent, heavy oil fractions are separated to produce heavy lubricating oil, catalytic cracking feedstock, and asphalt. Feedstock and liquid propane are pumped to an extraction tower at precisely controlled mixtures, temperatures (150°-250° F), and pressures of 350-600 psi. Separation occurs in a rotating disc contactor, based on differences in solubility. The products are then evaporated and steam stripped to recover the propane, which is recycled. Deasphalting also removes some sulfur and nitrogen compounds, metals, carbon residues, and paraffins from the feedstock.

**TABLE IV: 2-20. SOLVENT DEASPHALTING PROCESS.**

<b>Feedstock From</b>	<b>Process</b>	<b>Typical products . . . To</b>
Residual, reduced crude	Atmospheric tower & Vacuum tower	Heavy lube oil . . . Treating or lube blending Asphalt . . . . . Storage of shipping Deasphalted oil . . . Hydrotreat & catalytic cracker Propane . . . . . Recycle

2. **Safety and Health Considerations.**

- a. **Fire Protection and Prevention.** The potential for a fire exists if a product leak or release contacts a source of ignition such as the process heater. Condensed steam from the various asphalt and deasphalting processes will contain trace amounts of hydrocarbons. Any disruption of the vacuum can result in the entry of atmospheric air and subsequent fire. In addition, raising the temperature of the vacuum tower bottom to improve efficiency can generate methane by thermal cracking. This can create vapors in asphalt storage tanks that are not detectable by flash testing but are high enough to be flammable.
- b. **Safety.** Deasphalting requires exact temperature and pressure control. In addition, moisture, excess solvent, or a drop in operating temperature may cause foaming, which affects the product temperature control and may create an upset.
- c. **Health.** Because these are closed processes, exposures are expected to be minimal during normal operations. Should a spill or release occur, there is a potential for exposure to residuals and asphalt. Air blowing can create some polynuclear aromatics. Condensed steam from the air-blowing asphalt process may also contain contaminants. The potential for exposure to hydrogen sulfide and sulfur dioxide exists in the production of asphalt. Safe work practices and/or appropriate personal protective equipment may be needed for exposures to chemicals and other hazards such as noise and heat, and during process sampling, inspection, maintenance, and turnaround activities.

**R. HYDROGEN PRODUCTION.**

1. **Description.**

- a. High-purity hydrogen (95%-99%) is required for hydrodesulfurization, hydrogenation, hydrocracking, and petrochemical processes. Hydrogen, produced as a by-product of refinery processes (principally hydrogen recovery from catalytic reformer product gases), often is not enough to meet the total refinery requirements, necessitating the manufacturing of additional hydrogen or obtaining supply from external sources.
- b. In steam-methane reforming, desulfurized gases are mixed with superheated steam (1,100°-1,600° F) and reformed in tubes containing a nickel base catalyst. The reformed gas, which consists of steam, hydrogen, carbon monoxide, and carbon dioxide, is cooled and passed through converters containing an iron catalyst where the carbon monoxide reacts with steam to form carbon dioxide and more hydrogen. The carbon dioxide is removed by amine washing. Any remaining carbon monoxide in the product stream is converted to methane.
- c. Steam-naphtha reforming is a continuous process for the production of hydrogen from liquid hydrocarbons and is, in fact, similar to steam-methane reforming. A variety of naphthas in the gasoline boiling range may be employed, including fuel containing up to 35% aromatics. Following pretreatment to remove sulfur compounds, the feedstock is mixed with steam and taken to the reforming furnace (1,250°-1,500° F) where hydrogen is produced.

**TABLE IV: 2-21. STEAM REFORMING PROCESS.**

<b>Feedstock</b>	<b>From</b>	<b>Process</b>	<b>Typical products . . . To</b>
Desulfurized refinery gas	Various treatment units	Decomposition	Hydrogen . . . . . Processing Carbon dioxide . . . Atmosphere Carbon monoxide . . Methane

2. **Health and Safety Considerations.**

- a. **Fire Protection and Prevention.** The possibility of fire exists should a leak or release occur and reach an ignition source.
- b. **Safety.** The potential exists for burns from hot gases and superheated steam should a release occur. Inspections and testing should be considered where the possibility exists for valve failure due to contaminants in the hydrogen. Carryover from caustic scrubbers should be controlled to prevent corrosion in preheaters. Chlorides from the feedstock or steam system should be prevented from entering reformer tubes and contaminating the catalyst.
- c. **Health.** Because these are closed processes, exposures are expected to be minimal during normal operating conditions. There is a potential for exposure to excess hydrogen, carbon monoxide, and/or carbon dioxide. Condensate can be contaminated by process materials such as caustics and amine compounds, with resultant exposures. Depending on the specific process used, safe work practices and/or appropriate personal protective equipment may be needed for exposures to chemicals and other hazards such as noise and heat, and during process sampling, inspection, maintenance, and turnaround activities.

S. **BLENDING.**

- 1. **Description.** Blending is the physical mixture of a number of different liquid hydrocarbons to produce a finished product with certain desired characteristics. Products can be blended in-line through a manifold system, or batch blended in tanks and vessels. In-line blending of gasoline, distillates, jet fuel, and kerosene is accomplished by injecting proportionate

amounts of each component into the main stream where turbulence promotes thorough mixing. Additives including octane enhancers, metal deactivators, anti-oxidants, anti-knock agents, gum and rust inhibitors, detergents, etc. are added during and/or after blending to provide specific properties not inherent in hydrocarbons.

2. **Health and Safety Considerations.**

a. **Fire Prevention and Protection.** Ignition sources in the area need to be controlled in the event of a leak or release.

b. **Health.** Safe work practices and/or appropriate personal protective equipment may be needed for exposures to chemicals and other hazards such as noise and heat; when handling additives; and during inspection, maintenance, and turnaround activities.

T. **LUBRICANT, WAX, AND GREASE MANUFACTURING PROCESSES.**

1. **Description.** Lubricating oils and waxes are refined from the residual fractions of atmospheric and vacuum distillation. The primary objective of the various lubricating oil refinery processes is to remove asphalts, sulfonated aromatics, and paraffinic and isoparaffinic waxes from residual fractions. reduced crude from the vacuum unit is deasphalted and combined with straight-run lubricating oil feedstock, preheated, and solvent-extracted (usually with phenol or furfural) to produce raffinate.
2. **Wax Manufacturing Process.** Raffinate from the extraction unit contains a considerable amount of wax that must be removed by solvent extraction and crystallization. The raffinate is mixed with a solvent (propane) and precooled in heat exchangers. The crystallization temperature is attained by the evaporation of propane in the chiller and filter feed tanks. The wax is continuously removed by filters and cold solvent-washed to recover retained oil. The solvent is recovered from the oil by flashing and steam stripping. The wax is then heated with hot solvent, chilled, filtered, and given a final wash to remove all oil.
3. **Lubricating Oil Process.** The dewaxed raffinate is blended with other distillate fractions and further treated for viscosity index, color, stability, carbon residue, sulfur, additive response, and oxidation stability in extremely selective extraction processes using solvents (furfural, phenol, etc.). In a typical phenol unit, the raffinate is mixed with phenol in the treating section at temperatures below 400° F. Phenol is then separated from the treated oil and recycled. The treated lube-oil base stocks are then mixed and/or compounded with additives to meet the required physical and chemical characteristics of motor oils, industrial lubricants, and metal working oils.

**TABLE IV: 2-22. LUBRICATING OIL AND WAX MANUFACTURING PROCESSES.**

<b>Feedstock From</b>	<b>Process</b>	<b>Typical products . . . . To</b>
Lube feedstock and additives	Vacuum tower, solvent dewaxing, hydrotreating solvent extraction, etc.	Treatment Dewaxed raffinate . . . Lube blend or compound, grease compounding Wax . . . . . Storage or shipping

4. **Grease Compounding.** Grease is made by blending metallic soaps (salts of long-chained fatty acids) and additives into a lubricating oil medium at temperatures of 400°-600° F. Grease may be either batch-produced or continuously compounded. The characteristics of the grease depend to a great extent on the metallic element (calcium, sodium, aluminum, lithium, etc.) in the soap and the additives used.

5. **Safety and Health Considerations.**

- a. **Fire Protection and Prevention.** The potential for fire exists if a product or vapor leak or release in the lube blending and wax processing areas reaches a source of ignition. Storage of finished products, both bulk and packaged, should be in accordance with recognized practices.

While the potential for fire is reduced in lube oil blending, care must be taken when making metal-working oils and compounding greases due to the use of higher blending and compounding temperatures and lower flash point products.

- b. **Safety.** Control of treater temperature is important as phenol can cause corrosion above 400° F. Batch and in-line blending operations require strict controls to maintain desired product quality. Spills should be cleaned and leaks repaired to avoid slips and falls. Additives in drums and bags need to be handled properly to avoid strain. Wax can clog sewer or oil drainage systems and interfere with wastewater treatment.

- c. **Health.** When blending, sampling, and compounding, personal protection from steam, dusts, mists, vapors, metallic salts, and other additives is appropriate. Skin contact with any formulated grease or lubricant should be avoided. Safe work practices and/or appropriate personal protection may be needed for exposures to chemicals and other hazards such as noise and heat; during inspection, maintenance, and turnaround activities; and while sampling and handling hydrocarbons and chemicals during the production of lubricating oil and wax.

## V. OTHER REFINERY OPERATIONS.

### A. HEAT EXCHANGERS, COOLERS, AND PROCESS HEATERS.

1. **Heating Operations.** Process heaters and heat exchangers preheat feedstock in distillation towers and in refinery processes to reaction temperatures. Heat exchangers use either steam or hot hydrocarbon transferred from some other section of the process for heat input. The heaters are usually designed for specific process operations, and most are of cylindrical vertical or box-type designs. The major portion of heat provided to process units comes from fired heaters fueled by refinery or natural gas, distillate, and residual oils. Fired heaters are found on crude and reformer preheaters, coker heaters, and large-column reboilers.
2. **Cooling Operations.** Heat also may be removed from some processes by air and water exchangers, fin fans, gas and liquid coolers, and overhead condensers, or by transferring heat to other systems. The basic mechanical vapor-compression refrigeration system, which may serve one or more process units, includes an evaporator, compressor, condenser, controls, and piping. Common coolants are water, alcohol/water mixtures, or various glycol solutions.
3. **Health and Safety Considerations.**
  - a. **Fire Protection and Prevention.** A means of providing adequate draft or steam purging is required to reduce the chance of explosions when lighting fires in heater furnaces. Specific start-up and emergency procedures are required for each type of unit. If fire impinges on fin fans, failure could occur due to overheating. If flammable product escapes from a heat exchanger or cooler due to a leak, fire could occur.
  - b. **Safety.** Care must be taken to ensure that all pressure is removed from heater tubes before

removing header or fitting plugs. Consideration should be given to providing for pressure relief in heat-exchanger piping systems in the event they are blocked off while full of liquid. If controls fail, variations of temperature and pressure could occur on either side of the heat exchanger. If heat exchanger tubes fail and process pressure is greater than heater pressure, product could enter the heater with downstream consequences. If the process pressure is less than heater pressure, the heater stream could enter into the process fluid. If loss of circulation occurs in liquid or gas coolers, increased product temperature could affect downstream operations and require pressure relief.

c. **Health.** Because these are closed systems, exposures under normal operating conditions are expected to be minimal. Depending on the fuel, process operation, and unit design, there is a potential for exposure to hydrogen sulfide, carbon monoxide, hydrocarbons, steam boiler feed-water sludge, and water-treatment chemicals. Skin contact should be avoided with boiler blowdown, which may contain phenolic compounds. Safe work practices and/or appropriate personal protective equipment against hazards may be needed during process maintenance, inspection, and turnaround activities and for protection from radiant heat, superheated steam, hot hydrocarbon, and noise exposures.

## B. STEAM GENERATION.

1. **Heater and Boiler Operations.** Steam is generated in main generation plants, and/or at various process units using heat from flue gas or other sources. Heaters (furnaces) include burners and a combustion air system, the boiler enclosure in which heat transfer takes place, a draft or pressure system to remove flue gas from the furnace, soot blowers, and compressed-air systems that seal openings to prevent the escape of flue gas. Boilers consist of a number of tubes that carry the water-steam mixture through the furnace for maximum heat transfer. These tubes run between steam-distribution drums at the top of the boiler and water-collecting drums at the bottom of the boiler. Steam flows from the steam drum to the superheater before entering the steam distribution system.
2. **Heater Fuel.**
  - a. Heaters may use any one or combination of fuels including refinery gas, natural gas, fuel oil, and powdered coal. Refinery off-gas is collected from process units and combined with natural gas and LPG in a fuel-gas balance drum. The balance drum provides constant system pressure, fairly stable Btu-content fuel, and automatic separation of suspended liquids in gas vapors, and it prevents carryover of large slugs of condensate into the distribution system. Fuel oil is typically a mix of refinery crude oil with straight-run and cracked residues and other products. The fuel-oil system delivers fuel to process-unit heaters and steam generators at required temperatures and pressures. The fuel oil is heated to pumping temperature, sucked through a coarse suction strainer, pumped to a temperature-control heater, and then pumped through a fine-mesh strainer before being burned.
  - b. In one example of process-unit heat generation, carbon monoxide boilers recover heat in catalytic cracking units as carbon monoxide in flue gas is burned to complete combustion. In other processes, waste-heat recovery units use heat from the flue gas to make steam.
3. **Steam Distribution.** The distribution system consists of valves, fittings, piping, and connections suitable for the pressure of the steam transported. Steam leaves the boilers at the highest pressure required by the process units or electrical generation. The steam pressure is then reduced in turbines that drive process pumps and compressors. Most steam used in the refinery is condensed to water in various types of heat exchangers. The condensate is reused as boiler feedwater or discharged to wastewater treatment. When refinery steam is also used to drive steam turbine generators to produce electricity, the steam must be produced at much higher pressure than required for process steam. Steam typically is generated by heaters (furnaces) and boilers combined in one unit.
4. **Feedwater.**

a. Feedwater supply is an important part of steam generation. There must always be as many pounds of water entering the system as there are pounds of steam leaving it. Water used in steam generation must be free of contaminants including minerals and dissolved impurities that can damage the system or affect its operation. Suspended materials such as silt, sewage, and oil, which form scale and sludge, must be coagulated or filtered out of the water. Dissolved gases, particularly carbon dioxide and oxygen, cause boiler corrosion and are removed by deaeration and treatment. Dissolved minerals including metallic salts, calcium, carbonates, etc., that cause scale, corrosion, and turbine blade deposits are treated with lime or soda ash to precipitate them from the water. Recirculated cooling water must also be treated for hydrocarbons and other contaminants.

b. Depending on the characteristics of raw boiler feedwater, some or all of the following six stages of treatment will be applicable:

- Clarification;
- Sedimentation;
- Filtration;
- Ion exchange;
- Deaeration; and
- Internal treatment.

## 5. Health and Safety Considerations.

a. **Fire Protection and Prevention.** The most potentially hazardous operation in steam generation is heater startup. A flammable mixture of gas and air can build up as a result of loss of flame at one or more burners during light-off. Each type of unit requires specific startup and emergency procedures including purging before lightoff and in the event of misfire or loss of burner flame.

b. **Safety.** If feedwater runs low and boilers are dry, the tubes will overheat and fail. Conversely, excess water will be carried over into the steam distribution system and damage the turbines. Feedwater must be free of contaminants that could affect operations. Boilers should have continuous or intermittent blowdown systems to remove water from steam drums and limit buildup of scale on turbine blades and superheater tubes. Care must be taken not to overheat the superheater during startup and shut-down. Alternate fuel sources should be provided in the event of loss of gas due to refinery unit shutdown or emergency. Knockout pots provided at process units remove liquids from fuel gas before burning.

c. **Health.** Safe work practices and/or appropriate personal protective equipment may be needed for potential exposures to feedwater chemicals, steam, hot water, radiant heat, and noise, and during process sampling, inspection, maintenance, and turnaround activities.

## C. PRESSURE-RELIEF AND FLARE SYSTEMS.

1. **Pressure-Relief Systems.** Pressure-relief systems control vapors and liquids that are released by pressure-relieving devices and blow-downs. Pressure relief is an automatic, planned release when operating pressure reaches a predetermined level. Blowdown normally refers to the intentional release of material, such as blowdowns from process unit startups, furnace blowdowns, shutdowns, and emergencies. Vapor depressuring is the rapid removal of vapors from pressure vessels in case of fire. This may be accomplished by the use of a rupture disc, usually set at a higher pressure than the relief valve.
2. **Safety Relief Valve Operations.** Safety relief valves, used for air, steam, and gas as well as for vapor and liquid, allow the valve to open in proportion to the increase in pressure over the normal operating pressure. Safety valves designed primarily to release high volumes of steam usually pop open to full capacity. The overpressure needed to open liquid-relief valves where large-volume discharge is not required increases as the valve lifts due to increased spring resistance. Pilot-

operated safety relief valves, with up to six times the capacity of normal relief valves, are used where tighter sealing and larger volume discharges are required. Nonvolatile liquids are usually pumped to oil-water separation and recovery systems, and volatile liquids are sent to units operating at a lower pressure.

3. **Flare Systems.** A typical closed pressure release and flare system includes relief valves and lines from process units for collection of discharges, knockout drums to separate vapors and liquids, seals, and/or purge gas for flashback protection, and a flare and igniter system which combusts vapors when discharging directly to the atmosphere is not permitted. Steam may be injected into the flare tip to reduce visible smoke.

4. **Pressure Relief Health and Safety Considerations.**

- a. **Fire Protection and Prevention.** Vapors and gases must not discharge where sources of ignition could be present.

- b. **Safety.** Liquids should not be discharged directly to a vapor disposal system. Flare knockout drums and flares need to be large enough to handle emergency blowdowns. Drums should be provided with relief in the event of overpressure.

Pressure relief valves must be provided where the potential exists for overpressure in refinery processes due to the following causes:

- Loss of cooling water, which may greatly reduce pressure in condensers and increase the pressure in the process unit.
- Loss of reflux volume, which may cause a pressure drop in condensers and a pressure rise in distillation towers because the quantity of reflux affects the volume of vapors leaving the distillation tower.
- Rapid vaporization and pressure increase from injection of a lower boiling-point liquid including water into a process vessel operating at higher temperatures.
- Expansion of vapor and resultant over-pressure due to overheated process steam, malfunctioning heaters, or fire.
- Failure of automatic controls, closed outlets, heat exchanger failure, etc.
- Internal explosion, chemical reaction, thermal expansion, or accumulated gases.

Maintenance is important because valves are required to function properly. The most common operating problems are listed below.

- Failure to open at set pressure, because of plugging of the valve inlet or outlet, or because corrosion prevents proper operation of the disc holder and guides.
- Failure to reseal after popping open due to fouling, corrosion, or deposits on the seat or moving parts, or because solids in the gas stream have cut the valve disc.
- Chattering and premature opening, because operating pressure is too close to the set point.

- c. **Health.** Safe work practices and/or appropriate personal protective equipment may be needed to protect against hazards during inspection, maintenance, and turnaround activities.

#### D. WASTEWATER TREATMENT.

1. **Description.** Wastewater treatment is used for process, runoff, and sewerage water prior to discharge or recycling. Wastewater typically contains hydrocarbons, dissolved materials, suspended solids, phenols, ammonia, sulfides, and other compounds. Wastewater includes condensed steam, stripping water, spent caustic solutions, cooling tower and boiler blowdown, wash water, alkaline and acid waste neutralization water, and other process-associated water.
2. **Pretreatment Operations.** Pretreatment is the separation of hydrocarbons and solids from wastewater. API separators, interceptor plates, and settling ponds remove suspended

hydrocarbons, oily sludge, and solids by gravity separation, skimming, and filtration. Some oil-in-water emulsions must be heated to assist in separating the oil and water. Gravity separation depends on the specific gravity differences between water and immiscible oil globules and allows free oil to be skimmed off the surface of the wastewater. Acidic wastewater is neutralized using ammonia, lime, or soda ash. Alkaline wastewater is treated with sulfuric acid, hydrochloric acid, carbon dioxide-rich flue gas, or sulfur.

3. **Secondary Treatment Operations.** After pretreatment, suspended solids are removed by sedimentation or air flotation. Wastewater with low levels of solids may be screened or filtered. Flocculation agents are sometimes added to help separation. Secondary treatment processes biologically degrade and oxidize soluble organic matter by the use of activated sludge, unaerated or aerated lagoons, trickling filter methods, or anaerobic treatments. Materials with high adsorption characteristics are used in fixed-bed filters or added to the wastewater to form a slurry which is removed by sedimentation or filtration. Additional treatment methods are used to remove oils and chemicals from wastewater. Stripping is used on wastewater containing sulfides and/or ammonia, and solvent extraction is used to remove phenols.
4. **Tertiary Treatment Operations.** Tertiary treatments remove specific pollutants to meet regulatory discharge requirements. These treatments include chlorination, ozonation, ion exchange, reverse osmosis, activated carbon adsorption, etc. Compressed oxygen is diffused into wastewater streams to oxidize certain chemicals or to satisfy regulatory oxygen-content requirements. Wastewater that is to be recycled may require cooling to remove heat and/or oxidation by spraying or air stripping to remove any remaining phenols, nitrates, and ammonia.
5. **Health and Safety Considerations.**
  - a. **Fire Protection and Prevention.** The potential for fire exists if vapors from wastewater containing hydrocarbons reach a source of ignition during treatment.
  - b. **Health.** Safe work practices and/or appropriate personal protective equipment may be needed for exposures to chemicals and waste products during process sampling, inspection, maintenance, and turnaround activities as well as to noise, gases, and heat.

## E. COOLING TOWERS.

1. **Description.** Cooling towers remove heat from process water by evaporation and latent heat transfer between hot water and air. The two types of towers are crossflow and counterflow. Crossflow towers introduce the airflow at right angles to the water flow throughout the structure. In counterflow cooling towers, hot process water is pumped to the uppermost plenum and allowed to fall through the tower. Numerous slats or spray nozzles located throughout the length of the tower disperse the water and help in cooling. Air enters at the tower bottom and flows upward against the water. When the fans or blowers are at the air inlet, the air is considered to be forced draft. Induced draft is when the fans are at the air outlet.
2. **Cooling Water.** Recirculated cooling water must be treated to remove impurities and dissolved hydrocarbons. Because the water is saturated with oxygen from being cooled with air, the chances for corrosion are increased. One means of corrosion prevention is the addition of a material to the cooling water that forms a protective film on pipes and other metal surfaces.
3. **Health and Safety Considerations.**
  - a. **Fire Prevention and Protection.** When cooling water is contaminated by hydrocarbons, flammable vapors can be evaporated into the discharge air. If a source of ignition is present, or if lightning occurs, a fire may start. A potential fire hazard also exists where there are relatively dry areas in induced-draft cooling towers of combustible construction.
  - b. **Safety.** Loss of power to cooling tower fans or water pumps could have serious consequences in

the operation of the refinery. Impurities in cooling water can corrode and foul pipes and heat exchangers, scale from dissolved salts can deposit on pipes, and wooden cooling towers can be damaged by microorganisms.

c. **Health.** Cooling-tower water can be contaminated by process materials and by-products including sulfur dioxide, hydrogen sulfide, and carbon dioxide, with resultant exposures. Safe work practices and/or appropriate personal protective equipment may be needed during process sampling, inspection, maintenance, and turnaround activities; and for exposure to hazards such as those related to noise, water-treatment chemicals, and hydrogen sulfide when wastewater is treated in conjunction with cooling towers.

## F. ELECTRIC POWER.

1. **Description.** Refineries may receive electricity from outside sources or produce their own power with generators driven by steam turbines or gas engines. Electrical substations receive power from the utility or power plant for distribution throughout the facility. They are usually located in nonclassified areas, away from sources of vapor or cooling-tower water spray. Transformers, circuit breakers, and feed-circuit switches are usually located in substations. Substations feed power to distribution stations within the process unit areas. Distribution stations can be located in classified areas, providing that classification requirements are met. Distribution stations usually have a liquid-filled transformer and an oil-filled or air-break disconnect device.
2. **Health and Safety Considerations.**
  - a. **Fire Protection and Prevention.** Generators that are not properly classified and are located too close to process units may be a source of ignition should a spill or release occur.
  - b. **Safety.** Normal electrical safety precautions including dry footing, high-voltage warning signs, and guarding must be taken to protect against electrocution. Lockout/tagout and other appropriate safe work practices must be established to prevent energization while work is being performed on high-voltage electrical equipment.
  - c. **Health.** Safe work practices and/or the use of appropriate personal protective equipment may be needed for exposures to noise, for exposure to hazards during inspection and maintenance activities, and when working around transformers and switches that may contain a dielectric fluid which requires special handling precautions.

## G. GAS AND AIR COMPRESSORS.

1. **Description.** Both reciprocating and centrifugal compressors are used throughout the refinery for gas and compressed air. Air compressor systems include compressors, coolers, air receivers, air dryers, controls, and distribution piping. Blowers are used to provide air to certain processes. Plant air is provided for the operation of air-powered tools, catalyst regeneration, process heaters, steam-air decoking, sour-water oxidation, gasoline sweetening, asphalt blowing, and other uses. Instrument air is provided for use in pneumatic instruments and controls, air motors and purge connections.
2. **Health and Safety Considerations.**
  - a. **Fire Protection and Prevention.** Air compressors should be located so that the suction does not take in flammable vapors or corrosive gases. There is a potential for fire should a leak occur in gas compressors.
  - b. **Safety.** Knockout drums are needed to prevent liquid surges from entering gas compressors. If gases are contaminated with solid materials, strainers are needed. Failure of automatic compressor controls will affect processes. If maximum pressure could potentially be greater than compressor or process-equipment design pressure, pressure relief should be provided. Guarding is needed for

exposed moving parts on compressors. Compressor buildings should be properly electrically classified, and provisions should be made for proper ventilation.

Where plant air is used to back up instrument air, interconnections must be upstream of the instrument air drying system to prevent contamination of instruments with moisture. Alternate sources of instrument air supply, such as use of nitrogen, may be needed in the event of power outages or compressor failure.

c. **Health.** Safe work practices and/or appropriate personal protective equipment may be needed for exposure to hazards such as noise and during inspection and maintenance activities. The use of appropriate safeguards must be considered so that plant and instrument air is not used for breathing or pressuring potable water systems.

## H. MARINE, TANK CAR, AND TANK TRUCK LOADING AND UNLOADING.

1. **Description.** Facilities for loading liquid hydrocarbons into tank cars, tank trucks, and marine vessels and barges are usually part of the refinery operations. Product characteristics, distribution needs, shipping requirements, and operating criteria are important when designing loading facilities. Tank trucks and rail tank cars are either top- or bottom-loaded, and vapor-recovery systems may be provided where required. Loading and unloading liquefied petroleum gas (LPG) require special considerations in addition to those for liquid hydrocarbons.
2. **Health and Safety Considerations.**
  - a. **Fire Protection and Prevention.** The potential for fire exists where flammable vapors from spills or releases can reach a source of ignition. Where switch-loading is permitted, safe practices need to be established and followed. Bonding is used to equalize the electrical charge between the loading rack and the tank truck or tank car. Grounding is used at truck and rail loading facilities to prevent flow of stray currents. Insulating flanges are used on marine dock piping connections to prevent static electricity buildup and discharge. Flame arrestors should be installed in loading rack and marine vapor-recovery lines to prevent flashback.
  - b. **Safety.** Automatic or manual shutoff systems at supply headers are needed for top and bottom loading in the event of leaks or overfills. Fall protection such as railings are needed for top-loading racks where employees are exposed to falls. Drainage and recovery systems may be provided for storm drainage and to handle spills and leaks. Precautions must be taken at LPG loading facilities not to overload or overpressurize tank cars and trucks.
  - c. **Health.** The nature of the health hazards at loading and unloading facilities depends upon the products being loaded and the products previously transported in the tank cars, tank trucks, or marine vessels. Safe work practices and/or appropriate personal protective equipment may be needed to protect against hazardous exposures when loading or unloading, cleaning up spills or leaks, or when gauging, inspecting, sampling, or performing maintenance activities on loading facilities or vapor-recovery systems.

## I. TURBINES.

1. **Description.** Turbines are usually gas- or steam-powered and are typically used to drive pumps, compressors, blowers, and other refinery process equipment. Steam enters turbines at high temperatures and pressures, expands across and drives rotating blades while directed by fixed blades.
2. **Health and Safety Considerations.**
  - a. **Safety.** Steam turbines used for exhaust operating under vacuum should have safety relief valves on the discharge side, both for protection and to maintain steam in the event of vacuum failure. Where maximum operating pressure could be greater than design pressure, steam turbines

should be provided with relief devices. Consideration should be given to providing governors and overspeed control devices on turbines.

b. **Health.** Safe work practices and/or appropriate personal protective equipment may be needed for noise, steam and heat exposures, and during inspection and maintenance activities.

## J. PUMPS, PIPING AND VALVES.

### 1. Description.

a. Centrifugal and positive-displacement (i.e., reciprocating) pumps are used to move hydrocarbons, process water, fire water, and wastewater through piping within the refinery. Pumps are driven by electric motors, steam turbines, or internal combustion engines. The pump type, capacity, and construction materials depend on the service for which it is used.

b. Process and utility piping distribute hydrocarbons, steam, water, and other products throughout the facility. Their size and construction depend on the type of service, pressure, temperature, and nature of the products. Vent, drain, and sample connections are provided on piping, as well as provisions for blanking.

c. Different types of valves are used depending on their operating purpose. These include gate valves, bypass valves, globe and ball valves, plug valves, block and bleed valves, and check valves. Valves can be manually or automatically operated.

### 2. Health and Safety Considerations.

a. **Fire Protection and Prevention.** The potential for fire exists should hydrocarbon pumps, valves, or lines develop leaks that could allow vapors to reach sources of ignition. Remote sensors, control valves, fire valves, and isolation valves should be used to limit the release of hydrocarbons at pump suction lines in the event of leakage and/or fire.

b. **Safety.** Depending on the product and service, backflow prevention from the discharge line may be needed. The failure of automatic pump controls could cause a deviation in process pressure and temperature. Pumps operated with reduced or no flow can overheat and rupture. Pressure relief in the discharge piping should be provided where pumps can be overpressured. Provisions may be made for pipeline expansion, movement, and temperature changes to avoid rupture. Valves and instruments that require servicing or other work should be accessible at grade level or from an operating platform. Operating vent and drain connections should be provided with double-block valves, a block valve and plug, or blind flange for protection against releases.

c. **Health.** Safe work practices and/or appropriate personal protective equipment may be needed for exposure to hazards such as those related to liquids and vapors when opening or draining pumps, valves, and/or lines, and during product sampling, inspection, and maintenance activities.

## K. TANK STORAGE.

1. **Description.** Atmospheric storage tanks and pressure storage tanks are used throughout the refinery for storage of crudes, intermediate hydrocarbons (during the process), and finished products. Tanks are also provided for fire water, process and treatment water, acids, additives, and other chemicals. The type, construction, capacity and location of tanks depends on their use and materials stored.

### 2. Health and Safety Considerations.

a. **Fire Prevention and Protection.** The potential for fire exists should hydrocarbon storage tanks be overfilled or develop leaks that allow vapors to escape and reach sources of ignition. Remote sensors, control valves, isolation valves, and fire valves may be provided at tanks for pump-out or

closure in the event of a fire in the tank, or in the tank dike or storage area.

b. **Safety.** Tanks may be provided with automatic overflow control and alarm systems, or manual gauging and checking procedures may be established to control overfills.

c. **Health.** Safe work practices and/or appropriate personal protective equipment may be needed for exposure to hazards related to product sampling, manual gauging, inspection, and maintenance activities including confined space entry where applicable.

## VI. BIBLIOGRAPHY.

American Petroleum Institute. 1971. *Chemistry and Petroleum for Classroom Use in Chemistry Courses*. Washington, D.C.: American Petroleum Institute.

\_\_\_\_\_. 1973. *Industrial Hygiene Monitoring Manual for Petroleum Refineries and Selected Petrochemical Operations*. Manual 2700-1/79-1M. Washington, D.C.: American Petroleum Institute.

\_\_\_\_\_. 1980. *Facts About Oil*. Manual 4200-10/80-25M. Washington, D.C.: American Petroleum Institute.

\_\_\_\_\_. 1990. *Management of Process Hazards*. RP 750. Washington, D.C.: American Petroleum Institute.

\_\_\_\_\_. 1990. *Inspection of Piping, Tubing, Valves and Fittings*. RP 574. Washington, D.C.: American Petroleum Institute.

\_\_\_\_\_. 1991. *Inspection of Fired Boilers and Heaters*. RP 573. Washington, D.C.: American Petroleum Institute.

\_\_\_\_\_. 1992. *Inspection of Pressure Vessels*. RP 572. Washington, D.C.: American Petroleum Institute.

\_\_\_\_\_. 1992. *Inspection of Pressure Relieving Devices*. RP 576. Washington, D.C.: American Petroleum Institute.

\_\_\_\_\_. 1994. *Fire Protection in Refineries*. Sixth Edition. RP 2001. Washington, D.C.: American Petroleum Institute.

Armistead, George, Jr. 1950. *Safety in Petroleum Refining and Related Industries*. New York: John G. Simmons & Co., Inc.

Exxon Company, USA. 1987. *Encyclopedia for the User of Petroleum Products*. Lubetext D400. Houston: Exxon Company, USA.

Hydrocarbon Processing. 1988. *Refining Handbook*. Houston: Gulf Publishing Co.

\_\_\_\_\_. 1992. *Refining Handbook*. Houston: Gulf Publishing Co.

IARC. [No date given.] *Occupational Exposures in Petroleum Refining*. IARC Monographs, Volume 45.

Kutler, A. A. 1969. "Crude distillation." *Petro/Chem Engineering*. New York: John G. Simmons & Co., Inc.

Mobil Oil Corporation. 1972. "Light Products Refining, Fuels Manufacture." *Mobil Technical Bulletin*, 1972. Fairfax, Virginia: Mobil Oil Corporation.

Parmeggiani, Luigi, Technical Editor. 1983. *Encyclopaedia of Occupational Health and Safety*. Third Edition. Geneva: International Labour Organization.

Shell International Petroleum Company Limited. 1983. *The Petroleum Handbook*. Sixth Edition. Amsterdam: Elsevier Science Publishers B.V.

Speight, James G. 1980. *The Chemistry and Terminology of Petroleum*. New York: Marcel Dekker, Inc.

Vervalin, Charles H., Editor. 1985. *Fire Protection Manual for Hydrocarbon Processing Plants*. Volume 1, Third edition. Houston: Gulf Publishing Co.

#### **APPENDIX IV: 2-1. GLOSSARY.**

**ABSORPTION** The disappearance of one substance into another so that the absorbed substance loses its identifying characteristics, while the absorbing substance retains most of its original physical aspects. Used in refining to selectively remove specific components from process streams.

**ACID TREATMENT** A process in which unfinished petroleum products such as gasoline, kerosene, and lubricating oil stocks are treated with sulfuric acid to improve color, odor, and other properties.

**ADDITIVE** Chemicals added to petroleum products in small amounts to improve quality or add special characteristics.

**ADSORPTION** Adhesion of the molecules of gases or liquids to the surface of solid materials.

**AIR FIN COOLERS** A radiator-like device used to cool or condense hot hydrocarbons; also called fin fans.

**ALICYCLIC HYDROCARBONS** Cyclic (ringed) hydrocarbons in which the rings are made up only of carbon atoms.

**ALIPHATIC HYDROCARBONS** Hydrocarbons characterized by open-chain structures: ethane, butane, butene, acetylene, etc.

**ALKYLATION** A process using sulfuric or hydrofluoric acid as a catalyst to combine olefins (usually butylene) and isobutane to produce a high-octane product known as alkylate.

**API GRAVITY** An arbitrary scale expressing the density of petroleum products.

**AROMATIC** Organic compounds with one or more benzene rings.

**ASPHALTENES** The asphalt compounds soluble in carbon disulfide but insoluble in paraffin naphthas.

**ATMOSPHERIC TOWER** A distillation unit operated at atmospheric pressure.

**BENZENE** An unsaturated, six-carbon ring, basic aromatic compound.

**BLEEDER VALVE** A small-flow valve connected to a fluid process vessel or line for the purpose of bleeding off small quantities of contained fluid. It is installed with a block valve to determine if the block valve is closed tightly.

**BLENDING** The process of mixing two or more petroleum products with different properties to produce a finished product with desired characteristics.

**BLOCK VALVE** A valve used to isolate equipment.

**BLOWDOWN** The removal of hydrocarbons from a process unit, vessel, or line on a scheduled or emergency basis by the use of pressure through special piping and drums provided for this purpose.

**BLOWER** Equipment for moving large volumes of gas against low-pressure heads.

**BOILING RANGE** The range of temperature (usually at atmospheric pressure) at which the boiling (or distillation) of a hydrocarbon liquid commences, proceeds, and finishes.

**BOTTOMS** Tower bottoms are residue remaining in a distillation unit after the highest boiling-point material to be distilled has been removed. Tank bottoms are the heavy materials that accumulate in the bottom of storage tanks, usually comprised of oil, water, and foreign matter.

**BUBBLE TOWER** A fractionating (distillation) tower in which the rising vapors pass through layers of condensate, bubbling under caps on a series of plates.

**CATALYST** A material that aids or promotes a chemical reaction between other substances but does not react itself. Catalysts increase reaction speeds and can provide control by increasing desirable reactions and decreasing undesirable reactions.

**CATALYTIC CRACKING** The process of breaking up heavier hydrocarbon molecules into lighter hydrocarbon fractions by use of heat and catalysts.

**CAUSTIC WASH** A process in which distillate is treated with sodium hydroxide to remove acidic contaminants that contribute to poor odor and stability.

**CHD UNIT** See [Hydrodesulfurization](#).

**COKE** A high carbon-content residue remaining from the destructive distillation of petroleum residue.

**COKING** A process for thermally converting and upgrading heavy residual into lighter products and by-product petroleum coke. Coking also is the removal of all lighter distillable hydrocarbons that leaves a residue of carbon in the bottom of units or as buildup or deposits on equipment and catalysts.

**CONDENSATE** The liquid hydrocarbon resulting from cooling vapors.

**CONDENSER** A heat-transfer device that cools and condenses vapor by removing heat via a cooler medium such as water or lower-temperature hydrocarbon streams.

**CONDENSER REFLUX** Condensate that is returned to the original unit to assist in giving increased conversion or recovery.

**COOLER** A heat exchanger in which hot liquid hydrocarbon is passed through pipes immersed in cool water to lower its temperature.

**CRACKING** The breaking up of heavy molecular weight hydrocarbons into lighter hydrocarbon molecules by the application of heat and pressure, with or without the use of catalysts.

**CRUDE ASSAY** A procedure for determining the general distillation and quality characteristics of crude oil.

**CRUDE OIL** A naturally occurring mixture of hydrocarbons that usually includes small quantities of sulfur, nitrogen, and oxygen derivatives of hydrocarbons as well as trace metals.

**CYCLE GAS OIL** Cracked gas oil returned to a cracking unit.

**DEASPHALTING** Process of removing asphaltic materials from reduced crude using liquid propane to dissolve nonasphaltic compounds.

**DEBUTANIZER** A fractionating column used to remove butane and lighter components from liquid streams.

**DE-ETHANIZER** A fractionating column designed to remove ethane and gases from heavier hydrocarbons.

**DEHYDROGENATION** A reaction in which hydrogen atoms are eliminated from a molecule. Dehydrogenation is used to convert ethane, propane, and butane into olefins (ethylene, propylene, and butenes).

**DEPENTANIZER** A fractionating column used to remove pentane and lighter fractions from hydrocarbon

streams.

**DEPROPANIZER** A fractionating column for removing propane and lighter components from liquid streams.

**DESALTING** Removal of mineral salts (most chlorides, e.g., magnesium chloride and sodium chloride) from crude oil.

**DESULFURIZATION** A chemical treatment to remove sulfur or sulfur compounds from hydrocarbons.

**DEWAXING** The removal of wax from petroleum products (usually lubricating oils and distillate fuels) by solvent absorption, chilling, and filtering.

**DIETHANOLAMINE** A chemical ( $C_4H_{11}O_2N$ ) used to remove  $H_2S$  from gas streams.

**DISTILLATE** The products of distillation formed by condensing vapors.

**DOWNFLOW** Process in which the hydrocarbon stream flows from top to bottom.

**DRY GAS** Natural gas with so little natural gas liquids that it is nearly all methane with some ethane.

**FEEDSTOCK** Stock from which material is taken to be fed (charged) into a processing unit.

**FLASHING** The process in which a heated oil under pressure is suddenly vaporized in a tower by reducing pressure.

**FLASH POINT** Lowest temperature at which a petroleum product will give off sufficient vapor so that the vapor-air mixture above the surface of the liquid will propagate a flame away from the source of ignition.

**FLUX** Lighter petroleum used to fluidize heavier residual so that it can be pumped.

**FOULING** Accumulation of deposits in condensers, exchangers, etc.

**FRACTION** One of the portions of fractional distillation having a restricted boiling range.

**FRACTIONATING COLUMN** Process unit that separates various fractions of petroleum by simple distillation, with the column tapped at various levels to separate and remove fractions according to their boiling ranges.

**FUEL GAS** Refinery gas used for heating.

**GAS OIL** Middle-distillate petroleum fraction with a boiling range of about 350°-750° F, usually includes diesel fuel, kerosene, heating oil, and light fuel oil.

**GASOLINE** A blend of naphthas and other refinery products with sufficiently high octane and other desirable characteristics to be suitable for use as fuel in internal combustion engines.

**HEADER** A manifold that distributes fluid from a series of smaller pipes or conduits.

**HEAT** As used in the Health Considerations paragraphs of this document, heat refers to thermal burns for contact with hot surfaces, hot liquids and vapors, steam, etc.

**HEAT EXCHANGER** Equipment to transfer heat between two flowing streams of different temperatures. Heat is transferred between liquids or liquids and gases through a tubular wall.

**HIGH-LINE OR HIGH-PRESSURE GAS** High-pressure (100 psi) gas from cracking unit distillate drums that is compressed and combined with low-line gas as gas absorption feedstock.

**HYDROCRACKING** A process used to convert heavier feedstock into lower-boiling, higher-value products. The process employs high pressure, high temperature, a catalyst, and hydrogen.

**HYDRODESULFURIZATION** A catalytic process in which the principal purpose is to remove sulfur from petroleum fractions in the presence of hydrogen.

**HYDROFINISHING** A catalytic treating process carried out in the presence of hydrogen to improve the properties of low viscosity-index naphthenic and medium viscosity-index naphthenic oils. It is also applied to paraffin waxes and microcrystalline waxes for the removal of undesirable components. This process consumes hydrogen and is used in lieu of acid treating.

**HYDROFORMING** Catalytic reforming of naphtha at elevated temperatures and moderate pressures in the presence of hydrogen to form high-octane BTX aromatics for motor fuel or chemical manufacture. This process results in a net production of hydrogen and has rendered thermal reforming somewhat obsolete. It represents the total effect of numerous simultaneous reactions such as cracking, polymerization, dehydrogenation, and isomerization.

**HYDROGENATION** The chemical addition of hydrogen to a material in the presence of a catalyst.

**INHIBITOR** Additive used to prevent or retard undesirable changes in the quality of the product, or in the condition of the equipment in which the product is used.

**ISOMERIZATION** A reaction that catalytically converts straight-chain hydrocarbon molecules into branched-chain molecules of substantially higher octane number. The reaction rearranges the carbon skeleton of a molecule without adding or removing anything from the original material.

**ISO-OCTANE** A hydrocarbon molecule (2,2,4-trimethylpentane) with excellent antiknock characteristics on which the octane number of 100 is based.

**KNOCKOUT DRUM** A vessel wherein suspended liquid is separated from gas or vapor.

**LEAN OIL** Absorbent oil fed to absorption towers in which gas is to be stripped. After absorbing the heavy ends from the gas, it becomes fat oil. When the heavy ends are subsequently stripped, the solvent again becomes lean oil.

**LOW-LINE or LOW-PRESSURE GAS** Low-pressure (5 psi) gas from atmospheric and vacuum distillation recovery systems that is collected in the gas plant for compression to higher pressures.

**NAPHTHA** A general term used for low boiling hydrocarbon fractions that are a major component of gasoline. Aliphatic naphtha refers to those naphthas containing less than 0.1% benzene and with carbon numbers from  $C_3$  through  $C_{16}$ . Aromatic naphthas have carbon numbers from  $C_6$  through  $C_{16}$  and contain significant quantities of aromatic hydrocarbons such as benzene (>0.1%), toluene, and xylene.

**NAPHTHENES** Hydrocarbons (cycloalkanes) with the general formula  $C_nH_{2n}$ , in which the carbon atoms are arranged to form a ring.

**OCTANE NUMBER** A number indicating the relative antiknock characteristics of gasoline.

**OLEFINS** A family of unsaturated hydrocarbons with one carbon-carbon double bond and the general formula  $C_nH_{2n}$ .

**PARAFFINS** A family of saturated aliphatic hydrocarbons (alkanes) with the general formula  $C_nH_{2n+2}$ .

**POLYFORMING** The thermal conversion of naphtha and gas oils into high-quality gasoline at high temperatures and pressure in the presence of recirculated hydrocarbon gases.

**POLYMERIZATION** The process of combining two or more unsaturated organic molecules to form a single (heavier) molecule with the same elements in the same proportions as in the original molecule.

**PREHEATER** Exchanger used to heat hydrocarbons before they are fed to a unit.

**PRESSURE-REGULATING VALVE** A valve that releases or holds process-system pressure (that is, opens or closes) either by preset spring tension or by actuation by a valve controller to assume any desired position between fully open and fully closed.

**PYROLYSIS GASOLINE** A by-product from the manufacture of ethylene by steam cracking of hydrocarbon fractions such as naphtha or gas oil.

**PYROPHORIC IRON SULFIDE** A substance typically formed inside tanks and processing units by the corrosive interaction of sulfur compounds in the hydrocarbons and the iron and steel in the equipment. On exposure to air (oxygen) it ignites spontaneously.

**QUENCH OIL** Oil injected into a product leaving a cracking or reforming heater to lower the temperature and stop the cracking process.

**RAFFINATE** The product resulting from a solvent extraction process and consisting mainly of those components that are least soluble in the solvents. The product recovered from an extraction process is relatively free of aromatics, naphthenes, and other constituents that adversely affect physical parameters.

**REACTOR** The vessel in which chemical reactions take place during a chemical conversion type of process.

**REBOILER** An auxiliary unit of a fractionating tower designed to supply additional heat to the lower portion of the tower.

**RECYCLE GAS** High hydrogen-content gas returned to a unit for reprocessing.

**REDUCED CRUDE** A residual product remaining after the removal by distillation of an appreciable quantity of the more volatile components of crude oil.

**REFLUX** The portion of the distillate returned to the fractionating column to assist in attaining better separation into desired fractions.

**REFORMATE** An upgraded naphtha resulting from catalytic or thermal reforming.

**REFORMING** The thermal or catalytic conversion of petroleum naphtha into more volatile products of higher octane number. It represents the total effect of numerous simultaneous reactions such as cracking, polymerization, dehydrogenation, and isomerization.

**REGENERATION** In a catalytic process the reactivation of the catalyst, sometimes done by burning off the coke deposits under carefully controlled conditions of temperature and oxygen content of the regeneration gas stream.

**SCRUBBING** Purification of a gas or liquid by washing it in a tower.

**SOLVENT EXTRACTION** The separation of materials of different chemical types and solubilities by selective solvent action.

**SOUR GAS** Natural gas that contains corrosive, sulfur-bearing compounds such as hydrogen sulfide and mercaptans.

**STABILIZATION** A process for separating the gaseous and more volatile liquid hydrocarbons from crude petroleum or gasoline and leaving a stable (less-volatile) liquid so that it can be handled or stored with less change in composition.

**STRAIGHT-RUN GASOLINE** Gasoline produced by the primary distillation of crude oil. It contains no cracked, polymerized, alkylated, reformed, or visbroken stock.

**STRIPPING** The removal (by steam-induced vaporization or flash evaporation) of the more volatile components from a cut or fraction.

**SULFURIC ACID TREATING** A refining process in which unfinished petroleum products such as gasoline, kerosene, and lubricating oil stocks are treated with sulfuric acid to improve their color, odor, and other characteristics.

**SULFURIZATION** Combining sulfur compounds with petroleum lubricants.

**SWEETENING** Processes that either remove obnoxious sulfur compounds (primarily hydrogen sulfide, mercaptans, and thiophens) from petroleum fractions or streams, or convert them, as in the case of mercaptans, to odorless disulfides to improve odor, color, and oxidation stability.

**SWITCH LOADING** The loading of a high static-charge retaining hydrocarbon (i.e., diesel fuel) into a tank truck, tank car, or other vessel that has previously contained a low-flash hydrocarbon (gasoline) and may contain a flammable mixture of vapor and air.

**TAIL GAS** The lightest hydrocarbon gas released from a refining process.

**THERMAL CRACKING** The breaking up of heavy oil molecules into lighter fractions by the use of high temperature without the aid of catalysts.

**TURNAROUND** A planned complete shutdown of an entire process or section of a refinery, or of an entire refinery to perform major maintenance, overhaul, and repair operations and to inspect, test, and replace process materials and equipment.

**VACUUM DISTILLATION** The distillation of petroleum under vacuum which reduces the boiling temperature sufficiently to prevent cracking or decomposition of the feedstock.

**VAPOR** The gaseous phase of a substance that is a liquid at normal temperature and pressure.

**VISBREAKING** Viscosity breaking is a low-temperature cracking process used to reduce the viscosity or pour point of straight-run residuum.

**WET GAS** A gas containing a relatively high proportion of hydrocarbons that are recoverable as liquids.

[◀ TABLE OF CONTENTS](#)

[TOP ▲](#)

[NEXT CHAPTER ▶](#)

[▲ Back to Top](#)

[www.osha.gov](http://www.osha.gov)

[www.dol.gov](http://www.dol.gov)

---

[Contact Us](#) | [Freedom of Information Act](#) | [Customer Survey](#)  
[Privacy and Security Statement](#) | [Disclaimers](#)

---

Occupational Safety & Health Administration  
200 Constitution Avenue, NW  
Washington, DC 20210

Page last updated: 03/13/03